



KLINGELNBERG

P 65 | P 100

P 125 | P 152

PRECISION MEASURING CENTERS



KLINGELNBERG

Sustainable Quality Management of Drive Elements

Stringent precision requirements for gear tooth measurements and increasingly complex drive components demand the best measuring technology available and a machine and software concept optimized for these applications. That's why leading manufacturers put their trust in Klingenberg precision measuring centers, which represent the most widely used standard in the industry, while also serving as the reference for metrology institutes.

Klingenberg measuring centers (P-series) today are ideally suited to handle most measurement tasks in a wide range of sectors: Users in the automotive and commercial vehicle industries, the aerospace and aeronautical engineering industries, as well as the wind power industry rely on this technology, [which replaces up to six conventional measuring devices](#). This allows the following measurement tasks to be fully automated in a single setup:

- Gear measurement
- Optical measurement
- General coordinate measurement
- Form and position measurement
- Roughness measurement
- Contour measurement

The modular concept used in the P-series offers measuring devices in just the right size and a broad range of applications to provide the utmost in accuracy:

- Measuring centers for workpieces up to 3,800 mm in diameter and up to 20,000 kg in weight
- Gear measurements starting from module 0.1 mm



Winner of the iF Design Award 2018

P 65 – measuring range up to 650 mm

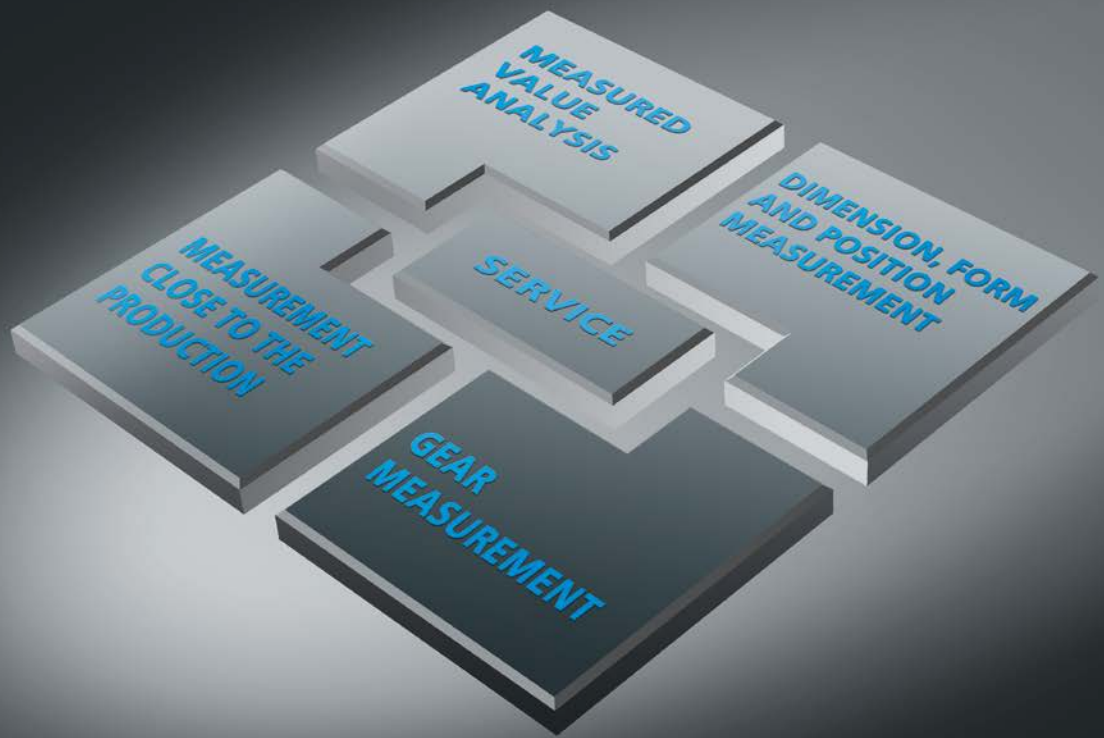

Close to the Market and to User Requirements

- First-class machine quality guarantees reliable quality assurance over the long term
- Robust measuring machine technology with low maintenance and calibration effort
- Excellent measuring accuracy as a basis for testing drive components of the highest quality
- Machine design suitable for use on the production floor
- Simple, easy operation of the measuring centers for all applications
- Continuous development of evaluation standards according to the specifications of industry and the standards associations
- Comprehensive service offering: fast, competent, worldwide

Cutting-Edge Technology for Maximum Safety and Precision

At the heart of a precision measuring center is an accurate, durable rotary table. Configured as a measuring axis (**C axis**), it provides concentric seating of the workpieces to be tested. In combination with the three linear measuring axes, tangential (**X axis**), radial (**Y axis**) and vertical (**Z axis**), the precision measuring centers reliably trace and inspect the functional surfaces of gearing and general drive components. This guarantees maximum measuring accuracy and reproducibility.

All Klingelberg measuring centers are equipped with heavy-duty, stable beds and guide bodies made of cast iron. At the same time, all bearings and guides are backlash-free at the measuring axes. These form the basis for the high basic mechanical accuracy of these measuring centers. The integrated 3D tracer head enables both discrete-point probing and scanning, continuous measured value logging. The powerful software makes it possible to evaluate the results quickly and easily (see page 11 for more on the software).

- Machine design with optimal axis arrangement
- High geometrical long-term stability thanks to large components for substructure and guide bodies
- Smooth, maintenance-free AC direct drives in all measuring axes
- Powerful, intuitive software
- Efficient data management through output of measuring results via a data network connection or printout

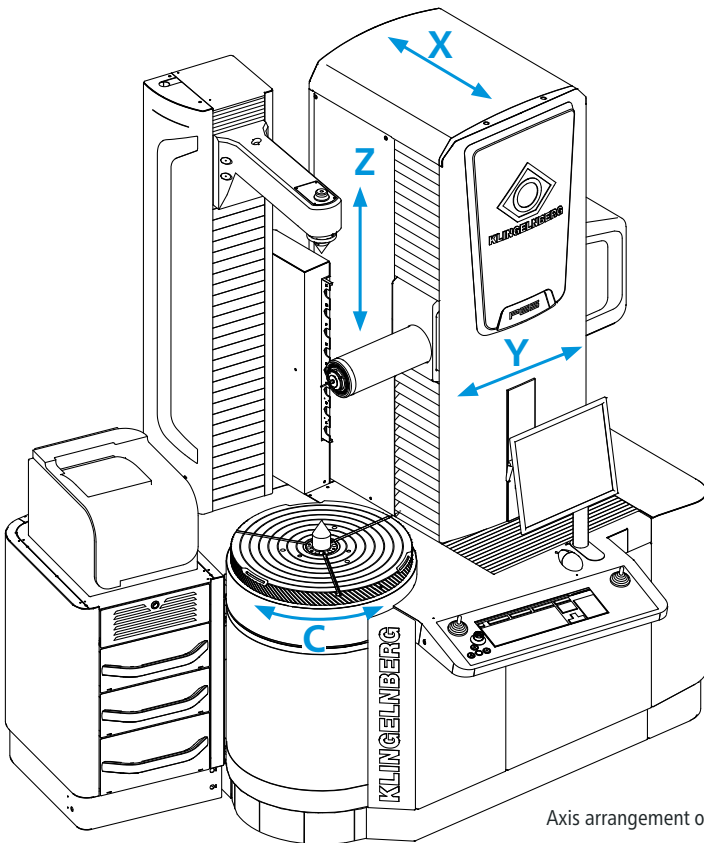

Axis arrangement of a precision measuring center

Bevel gear



Tooth thickness



Pitch, concentricity

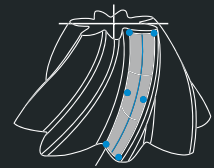

Topography

Cylindrical gear

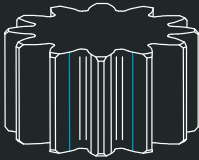

Lead line

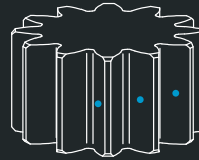

Pitch, concentricity

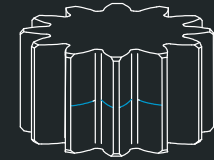

Profile

Shaft



Roundness



Straightness

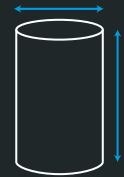

Diameter, length

Roughness

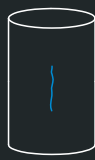

Shaft

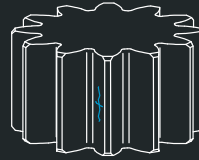

Cylindrical gear



Bevel gear

Contour

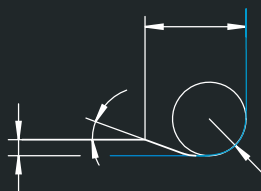

Radial and axial section scan



Tangential section scan



Normal section scan

Optical measurement



Pitch measurement on cylindrical gears

HIGHLIGHTS

Klingelnberg multisensor technology. Make the most of a broad range of scanning options

- 3D NANOSCAN in Controlled Direction Mode: perfect for all gear measurements
- 3D NANOSCAN in 3D Mode: high-precision scanning probing system for coordinate measurement
- Form measurement quality in all coordinate directions with 4 nanometer resolution
- Roughness probing systems for external and internal gearing as well as cylinder surfaces and bore holes
- Fully automatic measuring probe change, also for roughness measurement
- Optical sensor for high-resolution digitization with ultra-fast change operation
- Grinding burn sensor for measurement and evaluation according to the "Barkhausen Noise" principle

Precise, from the Ground Up

The measuring technology and machine design are the same for the entire P-series line. All machine models can be enhanced with individual options.



The Klingelnberg Precision Measuring Center P 152 – Components up to an outer diameter of 1,520 mm and a workpiece weight of up to 8,000 kg are measured with the usual precision.

- Minimal space requirement, also in the new design. Low-maintenance, durable technology minimizes running costs
- Shop-floor application thanks to temperature compensation ensures results in the +15 °C to +35 °C range
- Maximum application potential through multiple measuring sensors for coordinate, gearing, roughness and grinding burn measurements
- Roughness measurement of gearing, internal and external, on cylinder surfaces and bore holes
- Waviness analysis and production monitoring of cylindrical gear toothing without added measurement work



Fast and Accurate Measured Value Logging in Connection with a High-Precision Workpiece Rotary Table

- Extremely smooth-running rotary table axis in form-measurement quality
- Load reserves for impacts during workpiece loading
- Rotary table drive via AC torque motor (direct drive)
- Uniform, constant rotary transmission even at extremely slow motion
- Directly coupled angle measuring system with high absolute accuracy
- Table can be freely rotated when drive is shut down



High-Speed Measured Value Logging with Continuous Path Control

- CNC measurement control based on a Motorola PowerPC processor
- Coupled measuring movements of up to four axes simultaneously, also for form measurements
- High-speed measuring even with high measuring points densities
- Intelligent control response of rotary table axis for different workpieces (moments of inertia/workpiece coupling)



Broad Range of Applications Thanks to Versatile 3D NANOSCAN Tracer Head

- High-resolution scanning 3D tracer head with digital measured value logging in all coordinate directions
- Parallel-deflecting system for constant data calculation even with extended probe elements
- Automatic specification of trace direction in the X/Y plane when measuring lead lines with contact operation in the normal direction
- Measured value logging in form measurement quality
- Automatic compensation of different probe weights and adaptation of probe rods with multiple probe elements
- Automatic measuring probe change (optional)
- Scanning in axial, face, tangential and normal section



High Basic Accuracy With Low Tolerances

- Long-term stable geometry of all machine-mounted accessories and guide systems thanks to large size and use of high-quality materials
- Extremely smooth-running rotary tables even under load
- Use of length measuring/angle measuring systems in the highest accuracy classes
- Residual error calculation via special testing devices and controller-integrated compensation
- Modern assembly system with low error rates based on pretested modules
- Constant measuring accuracies of all machine models

HIGHLIGHTS



Maximum Safety with Collision Protection

- Software operator guidance with plausibility check of program data
- 3D tracer head with deflection motion monitoring via sensors and a mechanical protective device
- Probe change rack with bistable magnet holding system for easy handling and reliable collision protection
- Monitored measuring axis drives with overload protection function

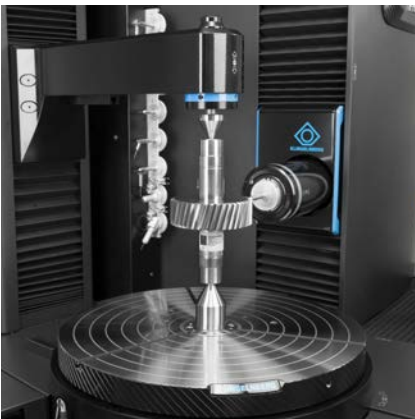

Industry-Compatible Calibration According to Recognized Standards

- Testing of all measuring centers with normals for profile and lead line, as well as workpiece-like normals of different types and sizes
- Traceability of measuring results to internationally recognized normals
- Proof of length measurement uncertainty MPE_E (optional)
- Proof of system suitability for form measurement tasks (optional)
- Determination of parameters Cg/Cgk and R&R testing (optional)



Quick Availability of Measuring Results Enables Huge Time Savings

- Correction of measuring results for workpiece temperatures deviating from the reference temperature in the +15 to +35 °C range
- Measurement of the current workpiece temperature via a fast thermoelement
- Algorithm can be used for all metallic/axially symmetrical workpieces



Automatic Roughness Measurement In- and Outside

- Skid-mounted tracer head for measured value logging on gearing with modules starting at 0.9 mm
- Output values acc. to DIN EN ISO 4287 (DIN 4762): R_a , R_z (DIN), R_t , R_{max} , R_{3z} , R_q , R_{pc} , R_k , R_{pk} , R_{vk} , MR_1 , MR_2 , R , AR
- Scanning in the profile or lead line direction with standardized trace sections
- Fully automatic operation in connection with profile and lead measurements, as well as for shaft probing and on plane surfaces
- Integrated actuator for diamond scanner alignment
- Probing systems for dimension, form and position of cylindrical and bevel gear toothing Manual or (optional) fully automatic measuring probe change



Versatile Measurement Tasks in One Setup

- Determination of measurement parameters such as diameter, length, angle, radius
- Determination of form and position parameters such as roundness, cylindrical shape, straightness, evenness, parallelism, symmetry, perpendicularity
- Measurement and evaluation macros for checking feather- and woodruff- keyways and for checking bore reference circles
- Measured value chart output for form measurements with filter levels standardized according to DIN EN ISO 1101
- Linking of dimension/form/length measurements with gear measurements (cylindrical gear/bevel gear) for a continuous, fully automatic measuring run
- Scanning in the axial / transverse section for measuring radii and clearance grooves, in the normal section for measuring tooth root radii and tip chamfers, as well as in the tangential section for measuring coupling elements



Fast Gear Development According to Nominal Data with "Closed Loop" Data Exchange

- Bevel gear tooth trace measurement compared against nominal data to be calculated
- Measurement of correction setting data for the machining method (cutting/grinding) based on current measured data
- Network data transmission for all integrated production facilities
- Ability to manufacture bevel gear sets (ring gear/pinion) as replaceable individual parts (grinding work)
- Reverse Engineering of bevel gear sets
- Tool measurement (stick blades) compared against calculated nominal data and reverse engineering with correction on the stick blade grinding machine

HIGHLIGHTS



Closed Loop for Cylindrical Gears

- Safe corrections thanks to error-free data transmission
- Elimination of error influencing variables through manual input
- Optimal process control through continuous closed loop process
- Data transmission via one standard interface
- Freely usable interface for cylindrical gear grinding machines



Optical Measuring Technology

- Fast measured value logging with high point density
- Rapid changeover between tactile and optical probing systems
- Very fast optical pitch measurement on cylindrical gears according to VDI/VDE 2613 Class 1 for reducing the pitch measurement time by up to 80%

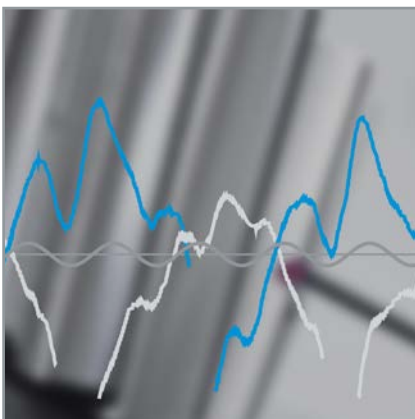

Analysis of Waviness

- Measurement of the smallest wavelike deviations in form on gearing and their evaluation
- Display of waviness and order spectra
- Automatic waviness evaluation from a standard profile and lead measurement
- Comparison with tolerance curves and OK/NOK evaluation
- Transfer of parameters to a statistics program

User-friendly Software Concept



Evaluation Software with Fully Automatic Measuring Run

Software plays a crucial role in the performance of a precision measuring center. It must be possible to test mandatory gearing evaluation parameters according to the national and international standards or special requirements of large corporations. The measuring run is fully automatic. The CNC control transmits the measurement reading online to the measurement software, where the results are evaluated. During the measuring run itself, the program displays results on the screen and then prints all necessary information on easy-to-read measuring sheets, and can also store these locally or via a network.



- Intuitive graphical user interface to Microsoft® Windows® standard – easy and secure operation with minimal training
- Graphical support for fast measurement program creation
- Tree structure with direct access to all input levels
- Catalog of stored measurement programs with search functions
- Measurement program with additional image documentation on the workpiece clamping situation
- Password protection for securing programming levels
- Repeat measurement evaluation without new measured value logging
- Individual choice of operator guidance/ documentation language
- EasyStart program for selecting different software modules
- Linking of cylindrical gear/bevel gear/shaft measurement programs (dimensional, form, positional deviations) for a fully automatic cycle
- Various interfaces for further processing of measuring results

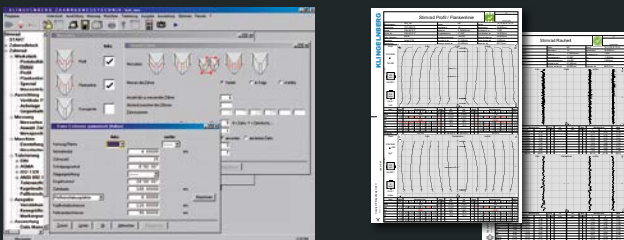

Cylindrical gears – easy, user-friendly interface with graphical elements and measuring sheets

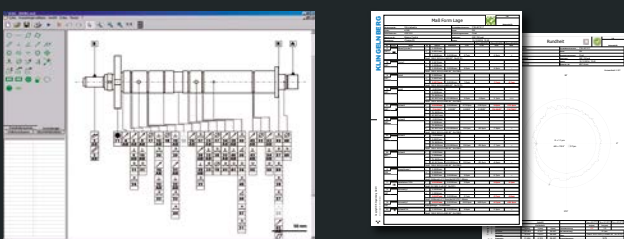

Dimension, form and position (shaft) – clear graphical user interface with display of measurement parameters and measuring sheets

EXPERTISE IN COUNTLESS INDUSTRIES

Drive Components with Guaranteed Quality Provide Optimal Performance

Commercial vehicles and passenger vehicles rate among the essential elements of daily utility requirements and transport facilities. In doing so, next to a high safety and a reliable function, these vehicles must also have a long operating life as well as a high economic efficiency.

Thus in difficult operating conditions in the construction industry or in the mountains, high power reserves of the drive systems are expected that can only be ensured by the production quality of the components used. A quality assurance of the components using high-quality measurement systems is therefore a basic prerequisite.

Typical applications are shown below.



Commercial Vehicle Transmission & Coupling Components



Vehicle Engine & Axis Components



Industrial Gear Units

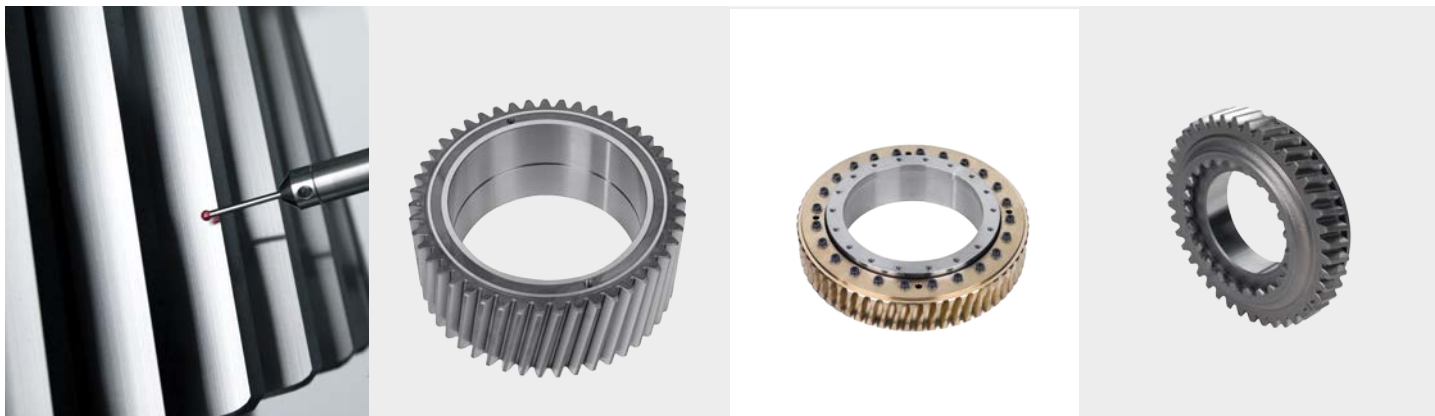

Compressor Rotors

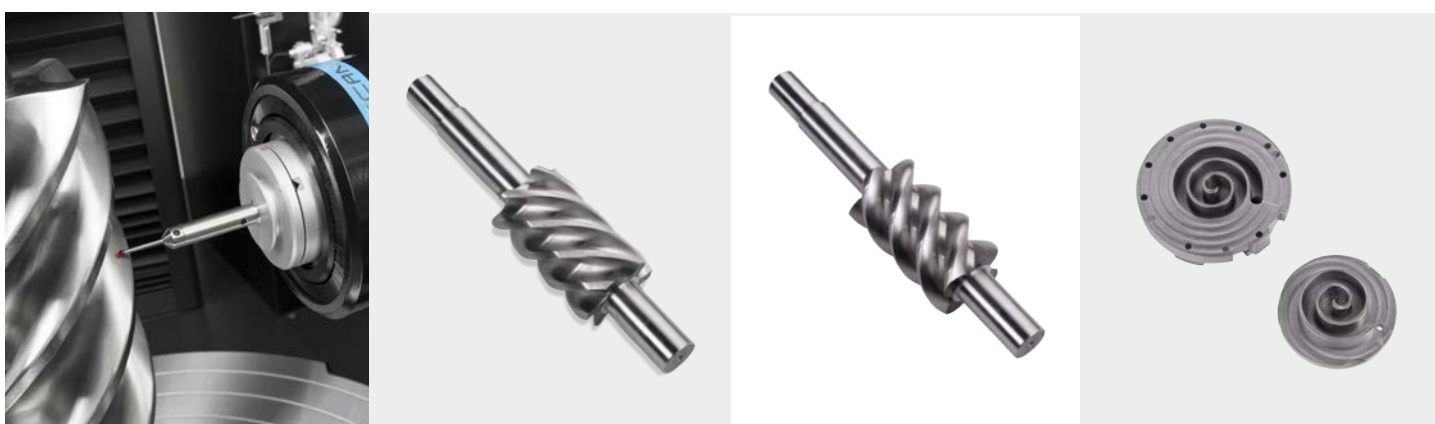

Special Measurement Tasks

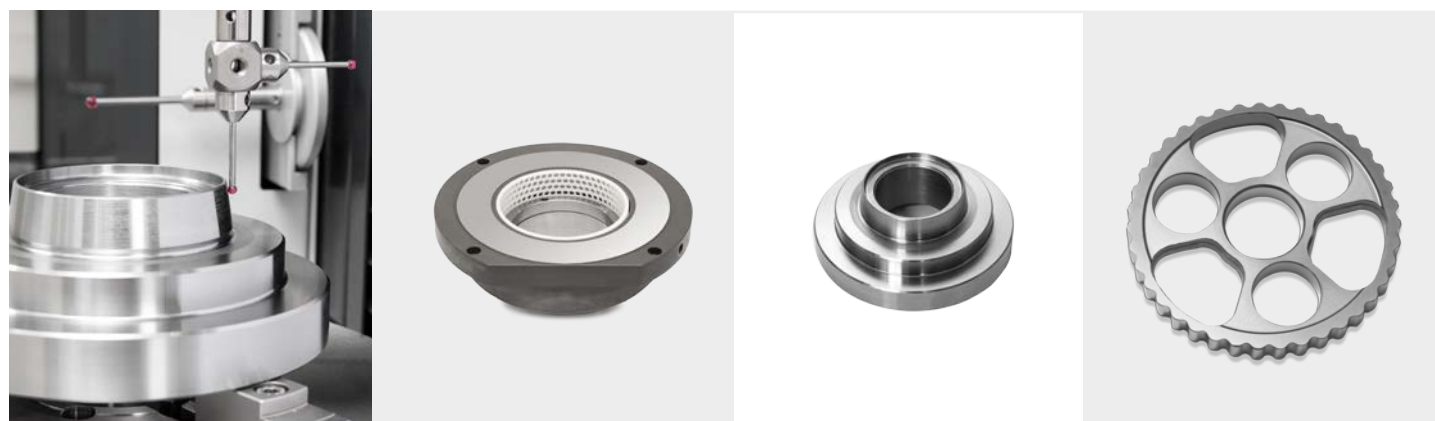

Gear Cutting Tools

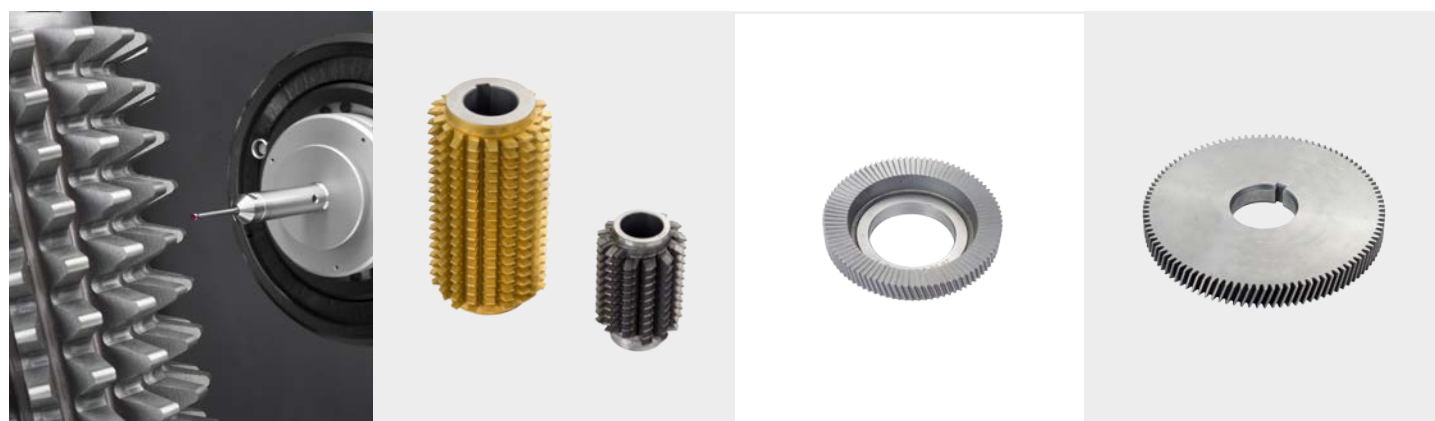

TECHNICAL DATA

	P 65	P 100	P 125	P 152
Module range (min. – max.)	0.30 – 35 mm (0.20 – 35 mm)*2	0.30 – 50 mm (0.20 – 50 mm)*2	0.30 – 50 mm (0.20 – 50 mm)*2	1 – 65 mm
Horizontal measuring range (generating path, X axis)	±200 mm	±200 mm	±200 mm	±200 mm
Clamping/testing diameter of cylindrical gears between centers (max.)	650 mm	1,000 mm	1,250 mm	1,520 mm
Permissible moment of inertia (max.)	30 kgm ²	100 kgm ²	100 kgm ²	2,000 kgm ²
Permissible workpiece weight, approx. (max.)	500 kg	2,000 kg	2,000 kg	8,000 kg
Vertical measuring range (Z axis)	800 (1,200) mm *7	800 (1,200) mm	800 (1,200) mm	1,200 (1,500) mm *10
Distance between centers	50 – 1,000 mm (50 – 1,500 mm) *7	50 – 1,000 mm (50 – 1,500 mm)	75 – 1,500 mm	65 – 1,500 mm (65 – 2,000 mm) *10
Machine accuracy gear measurement according to VDI/VDE 2612 sheet 6 *6	Class A	Class A	Class A	Class A
Machine accuracy at + 18 °C – 22 °C				
Reference temperatures	0.5 K/h; 2 K/d; 2 K/m	0.5 K/h; 2 K/d; 2 K/m	0.5 K/h; 2 K/d; 2 K/m	0.5 K/h; 2 K/d; 2 K/m
MPEE0 ISO 10360-2 (2010) *3/*4/*6	1.8 µm + L/450 mm	1.8 µm + L/450 mm	1.8 µm + L/450 mm	2.2 µm + L /250mm
Roundness Ø 100/L VDI/ VDE2617- sheet 8 *4/*5/*6	0.3 µm	0.3 µm	0.3 µm	0.5 µm
Total axial runout VDI/VDE2617- sheet 8 *4/*6	1.5 µm	1.5 µm	1.5 µm	1.8 µm
Machine accuracy at +15 °C – 35 °C				
Reference temperatures	2 K/h; 12 K/d; 2 K/m	2 K/h; 12 K/d; 2 K/m	2 K/h; 12 K/d; 2 K/m	-
MPEE0 ISO 10360-2 (2010) *3/*4/*6	1.8 µm + L/250 mm	1.8 µm + L/250 mm	1.8 µm + L/250 mm	-
Roundness Ø 100/L VDI/ VDE2617- sheet 8 *4/*5/*6	0.5 µm	0.5 µm	0.5 µm	-
Total axial runout VDI/VDE2617- sheet 8 *4/*6	1.8 µm	1.8 µm	1.8 µm	-
Total connected load of the machine	2.3 kVA	2.3 kVA	2.3 kVA	3.5 kVA
Compressed air connection	6 bar – 1 l/min	6 bar – 1 l/min	6 bar – 1 l/min	6 bar – 2 l/min
Net weight incl. standard equipment approx.	3,950 kg	4,000 kg	5,400 kg	7,275 kg
Machine dimensions (L x W x H) approx.	1,770 x 2,125 x 2,430 (2,930) mm	1,820 x 2,315 x 2,430 (2,930) mm	2,420 x 1,900 x 2,930 mm	2,800 x 2,390 x 3,200 (3,700) mm

(Values in brackets are optional)

*2 Only in combination with options

*3 Reduced shape in axis-parallel direction

*4 Use of the prescribed Klingelnberg stylus configurations respectively at Klingelnberg SFP Normal

*5 At turn table height

*6 Maximum permissible vibration speed, vertical, horizontal: 0.1 mm/s peak to peak

*7 By using the optical sensor Optoscan the amount is reduced by 70 mm

*10 Not with active vibration isolation

Subject to technical changes. The finish (color, design) can be taken from the offer.

Installation dimensions

P 65

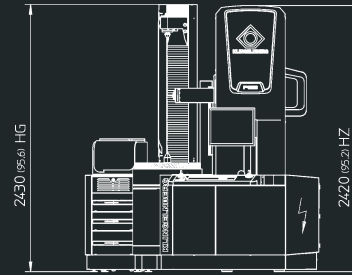
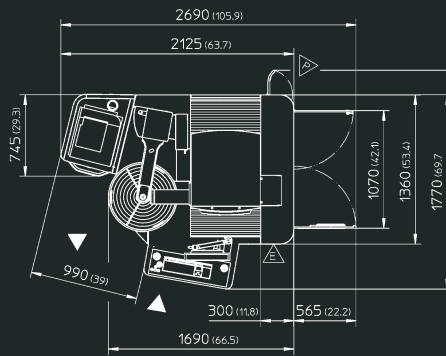

P 100

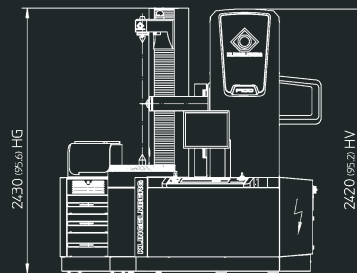
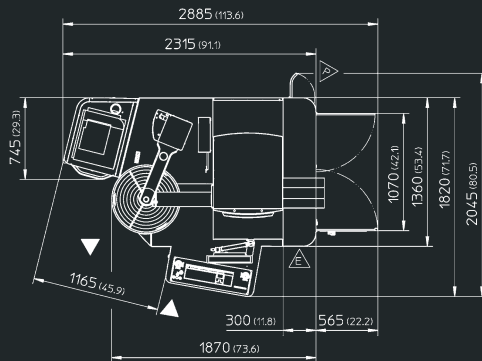

P 125

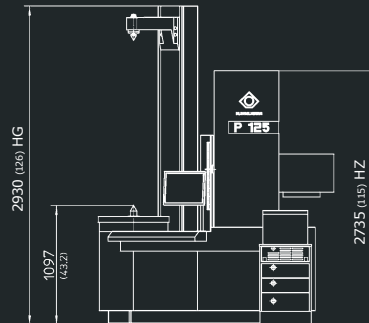
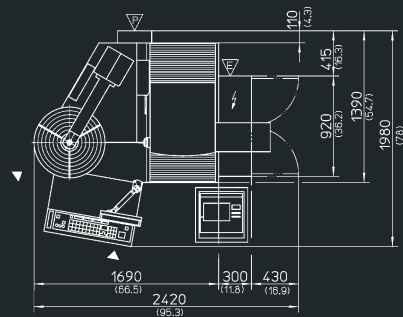

P 152

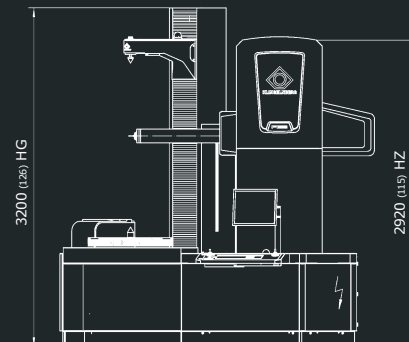
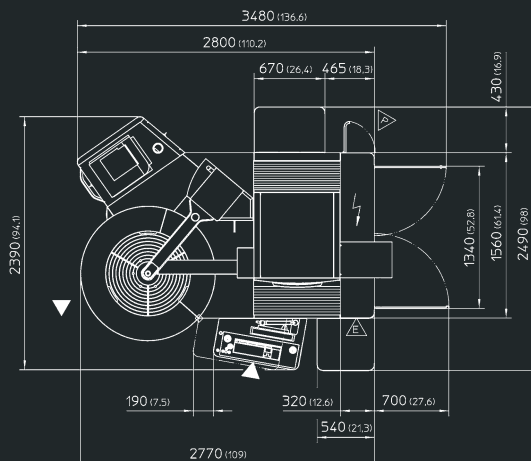

All dimensions in mm (inch)

KLINGELNBERG Service

The KLINGELNBERG Group is a world leader in the development and manufacture of machines for bevel gear and cylindrical gear production, and precision measuring centers for gearing and axially symmetrical components, as well as the production of customized high-precision drive components. In addition to the headquarters in Zurich, Switzerland, further development and production facilities are located in Hückeswagen and Ettlingen, Germany.

The company also maintains a presence with Sales and Service offices and numerous marketing agents. On this basis, Klingelberg offers users a comprehensive range of services for all aspects of toothed gear design, manufacturing, and quality inspection. The spectrum includes technical consulting, on-site machine acceptance, operator and software training as well as maintenance contracts.

KLINGELNBERG Solutions

Klingelberg solutions are used in the automotive, commercial vehicle, and aviation industries, as well as in shipbuilding, the wind power industry, and the general transmission manufacturing industry. With numerous R&D engineers around the globe and over 200 registered patents, the company consistently demonstrates its capacity for innovation.

EN 10/2023- Subject to technical modifications without notice.

FOLLOW US AND STAY UP TO DATE:



KLINGELNBERG AG

Binzmühlestrasse 171
8050 Zürich, Switzerland
Fon: +41 44 278 7979
Fax: +41 44 273 1594

KLINGELNBERG GmbH

Peterstraße 45
42499 Hückeswagen, Germany
Fon: +49 2192 81-0
Fax: +49 2192 81-200

KLINGELNBERG GmbH

Industriestraße 5-9
76275 Ettlingen, Germany
Fon: +49 7243 599-0
Fax: +49 7243 599-165

You can also find your local contact for sales advice at <https://klingelberg.com/en/contact>