



**HÖFLER**

**RAPID 2500-8000**

CYLINDRICAL GEAR TECHNOLOGY – GRINDING MACHINES



**KLINGELBERG**

## Innovative Cylindrical Gear Machining for Flexible Requirements

All around the world, manufacturers of gears and transmissions ensure their leading edge in gear machining with innovative solutions by Klingelberg. High research and development standards, a global service network, and an in-house application engineering service ensure a leadership position – now and in the years to come – thanks to our decades-long expertise and high innovation capacity.

The [Höfler Cylindrical Gear Technology](#) division makes economical, high-precision production of cylindrical gears a reality for customers, with a portfolio that includes cylindrical gear grinding machines for generating grinding, profile grinding, and internal gear grinding, among others. A key factor in the successful completion of each work step is the [Gear Production](#) software, providing optimal process control and extreme ease-of-operation to guarantee maximum efficiency in the daily production routine.

Klingelberg also consistently strives to develop innovations and solutions to enhance productivity – and sets the same standard for measuring technology. Machine tool networking with the [Klingelberg Precision Measuring Centers](#) creates a digital process and quality control system within the [Closed Loop concept](#). Klingelberg also offers individual services. In addition to machine maintenance and repair, a number of upgrade options and add-on functions are available.

Höfler cylindrical gear machines are developed with real-world applications in mind and satisfy a whole host of application industry requirements. Customers include contract gear manufacturers and gearbox manufacturers in the aviation, automotive, mining, construction, industrial gearbox, maritime drive technology, and wind power industries.



Höfler cylindrical gear grinding machine RAPID 8000 AI for component diameters of up to 8,000 mm

# Exceptional Concepts in the Gearing Process

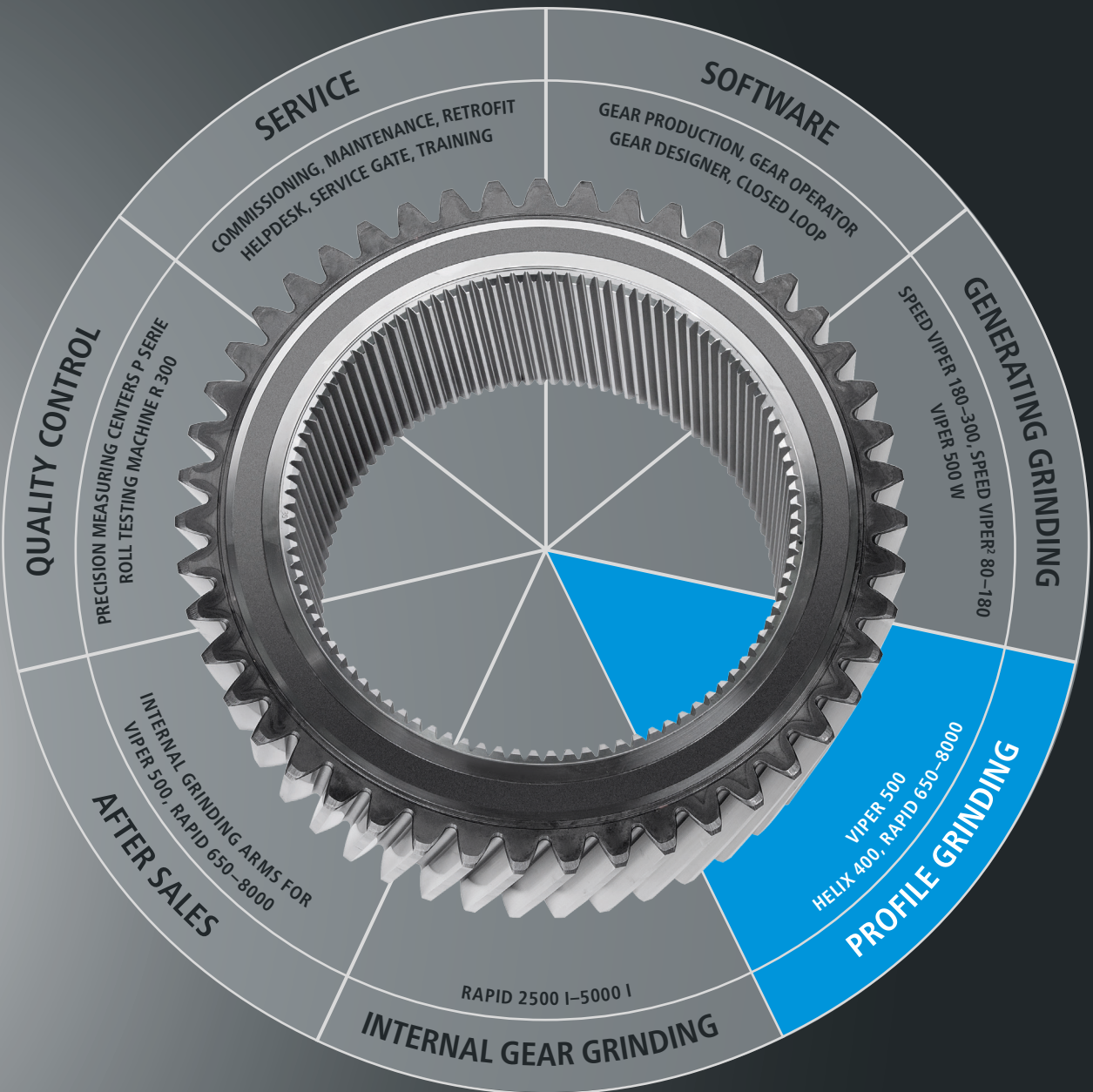

## Cutting-Edge Technology for Maximum Performance and Efficiency

The profile grinding machines of the RAPID series for **large workpiece sizes** are designed to handle **component diameters of up to 8,000 mm**. Depending on individual requirements, they are fitted with an **increased stroke range (L variant)** and are furthermore available in two different variants. As well as the standard configuration, the machine can be supplied with a small grinding head for holding very small grinding wheel diameters of 300-20 mm (**K variant**). In all configurations, the machines in the RAPID series can be retooled from external to internal gears in no time at all using optional internal gear grinding arms.

What's more, the special machine axes arrangement, a thermally stable and almost vibration-free machine bed made of cast polymer, as well as wear-free torque drives in the machine table and the grinding head for 5-axis grinding all contribute to the machine's tried-and-tested precision, consistent quality, and tremendous flexibility. The highly flexible grinding head with integrated 3D probe and helix angle adjustment during the grinding process mean that gears can be modified topologically depending on permissible deviations in single-flank or double-flank grinding, while measurements using the optional test equipment ensure a controlled grinding result even in the grinding process.

- Stable, almost vibration-free beds made of cast polymer
- Precise control of the fully hydrostatic machine table via torque motor drive
- Highly dynamic axes allow optimized 5-axis machining of an entire range of modifications in the shortest possible grinding time
- Automatic table drive optimization without the user intervention at each workpiece change
- Controlled grinding result thanks to integrated measurements and automatic corrections in the grinding process (optional)

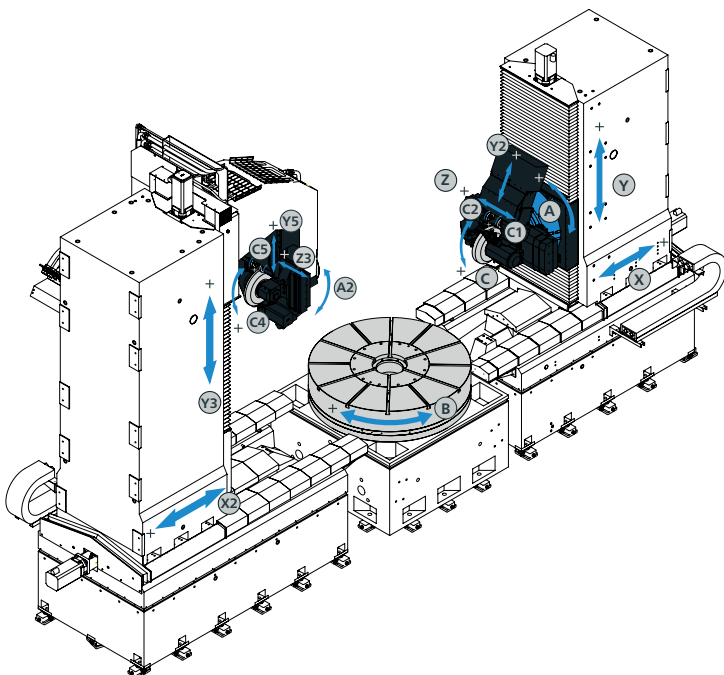

Schematic diagram of the axes using a RAPID 4000 AI as an example

### CNC axes

- |   |   |
|---|---|
| X   | Tool stands   |
| Y   | Lifting slide   |
| B   | Machine table   |
| A   | Helix angle   |
| Z   | Shift axis  |
| Y <sub>2</sub>                                      | Dressing axis   |
| C, C <sub>1</sub> , C <sub>4</sub> , C <sub>5</sub> | Regulated grinding wheel and diamond dressing roll drives |

# The Perfect Machine Configuration for Every Requirement

## External Gearings

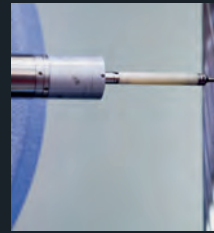

Small Grinding Wheels  
(K Head)

Large Modules

External Gearing  
Checks

## Internal Gearings\*

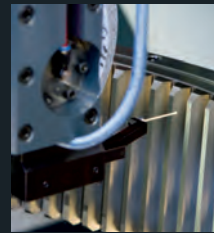
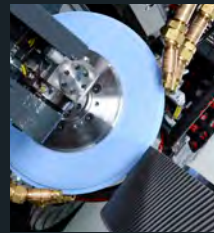

Straight Gearings

Extreme  
Helical Toothing

Internal Gearing  
Checks

## HIGHLIGHTS

### Best-fit Grinding: Maximum Precision Ensures Improved Process Efficiency!

Thanks to the Best-fit Grinding system, RAPID machines come equipped with technology that solves the problem of limited performance during the grinding process caused by unequal stock removal ratios when the grinding wheel is fed radially.

- Additional infeed movements occur parallel to the radial infeed without losing time
- Even stock removal across the entire profile height thanks to the optimized 4-axis infeed
- Combination with High-speed Grinding technology possible
- Low thermal differences and uniform stock removal across the entire tooth flank
- Significant reduction in the number of strokes in the cutting process

#### Result:

Grinding times can be **reduced by up to 30 %** thanks to the stroke-specific optimization of the grinding wheel position.

### High-tech can be so easy!

“Simplified with Passion” – true to this motto, Klingelberg is driven to provide simple, unconventional solutions to high-tech challenges. A team of engineers and technical experts makes it possible – continually striving to ensure the highest technological standards in application-matched machine concepts while maintaining ease of use.

Case in point: The grinding machines of the RAPID series are based on established design concepts that are continually undergoing further development. Klingelberg’s success factors include:

- High productivity with the lowest possible per-piece costs and maximum process safety
- Comprehensive service with a broad service network
- Outstanding technical expertise, which Klingelberg passes on to its customers in professional seminars



Höfler cylindrical gear grinding machine RAPID 2500 for component diameters of up to 2,500 mm

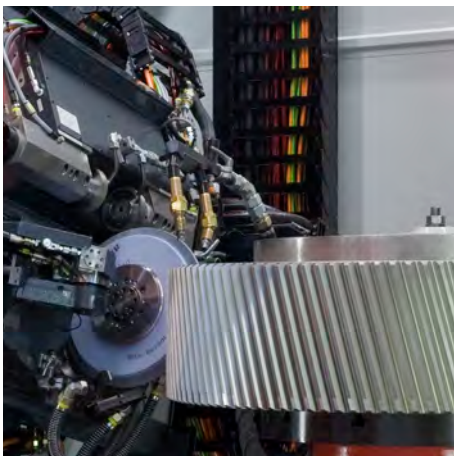

### Highly Flexible Grinding Head with Torque Motor Swivel Drive

- Genuine 5-axis machining possible
- Maximum rigidity and positioning precision as well as no wear even during the grinding process
- Grinding head position monitoring thanks to integrated measurement system
- Topological modifications according to requirements in single-flank or double-flank grinding
- Integrated measuring device with 3D probe for checking the most difficult topologies on the grinding machine

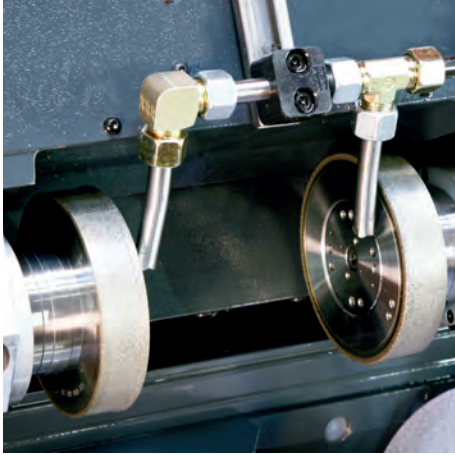

## Reducing Traversing Paths Thanks to the Grinding Wheel Double-Dressing System

- The double-dressing system is positioned directly on the grinding head and fitted with two diamond dressing rolls
- Reduced traversing paths and dressing times
- Freely dressable profile heights on the grinding wheel
- Highly accurate and low-wear grinding wheel profiling according to different parameters

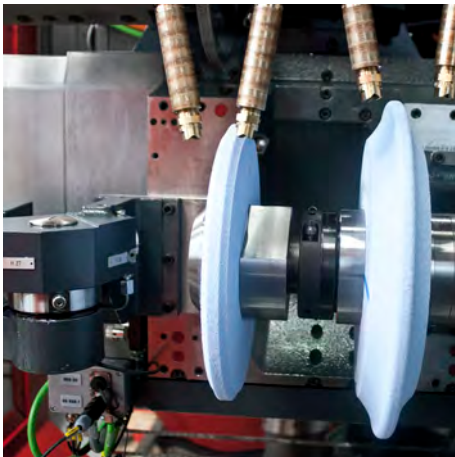

## Spindle Options for Special Requirements (K Variant)

- Double helical gears with small gap distances
- In cases where tooting gaps are small: pinion shafts and spline gears, for example
- Various grinding wheel adapters for grinding wheel diameters of 300-20 mm
- No spindle change required
- Dressable and non-dressable CBN grinding wheels available

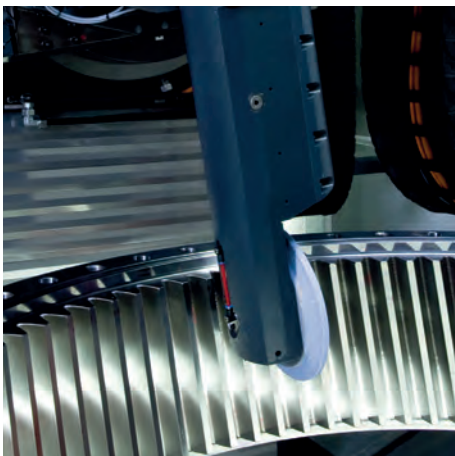

## Internal Gear Grinding Arms (Optional)

- Various internal gear grinding arms available depending on application and sector
- Easy assembly for quick set-up times
- Grinding of straight and helical gears or couplings
- Separate dressing unit inside the machine based on the principle of dressing for external gearings

## HIGHLIGHTS

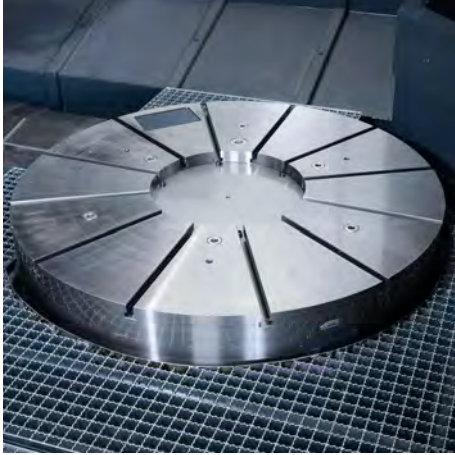

### Precise Machine Table Control via Torque Motor Drive

- High engine torque of up to 50 rpm reduces alignment and pitch times, and facilitates the external cylindrical grinding of gear wheels
- Automatic table drive adaptation to changing mass moments of inertia, without any user intervention
- Wear-free torque motor ensures high investment security
- Fast, maintenance-free, high-precision

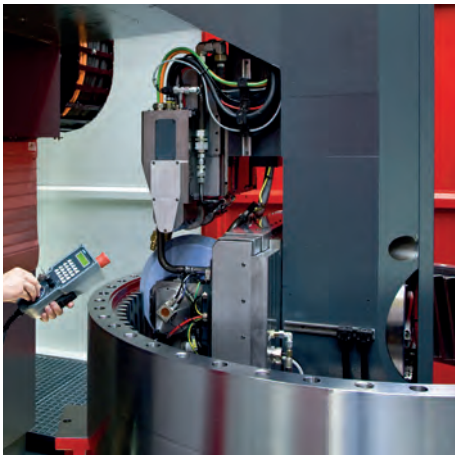

### Two-Column Version with RAPID AI Variant for Large-Module Gearings (Optional)

- External and internal machining in a single machine without retooling, with the same clamping
- Integrated swivel axis
- Integrated dressing unit
- Insertion depth up to 1,000 mm
- Internal gears with large helix angles are also grindable without collision

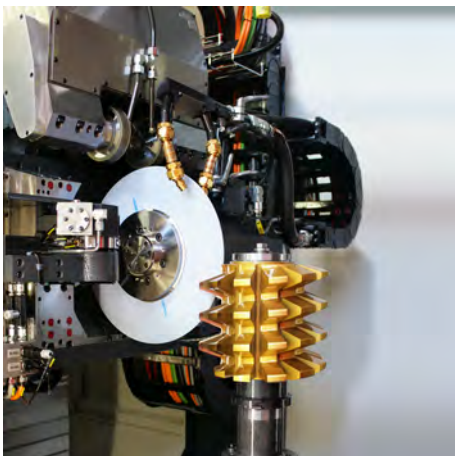

### Hob Sharpening

- Costs reduced as specialist machines are no longer required
- Automatic tool centering thanks to measuring probe and grinding wheel
- Freely adjustable process values and dressing parameters minimize the tool surface roughness and increase its quality and service life
- Ideal even for very large hobs
- Profile, tooth flank, and pitch of the sharpened surfaces can be measured



# Numerous Performance Profiles and Custom Options Provide Greater Flexibility During the Grinding Process

## Standard Performance Profiles

- Grinding and inspecting cylindrical external gearings
- Standard modifications in profile and tooth flank direction
- Easy-to-use operator guidance, various wizards, automatic 3D collision control
- Siemens electronics: Siemens 840 D control system

## Optional Performance Profiles

- Grinding and inspecting cylindrical internal gearings
- High-speed Grinding (HSG)
- Best-fit Grinding (BFG)
- Grinding with CBN grinding wheels
- Multi-grinding wheel technology
- Eccentric compensation
- Adaptive Dressing Interval (ADI)
- Dresser Contact Control (DCC)
- Dresser Life Control (DLC)
- Grinding and inspecting double helical toothings
- Grinding and inspecting multiple gearings
- Grinding reference collars and thrust collars
- Grinding non pre-toothed workpieces
- Grinding extra-wide profiles
- Grinding special profiles
- Grinding and inspecting asymmetrical involutes
- Bias-Controlled Grinding (BCG)
- Grinding and inspecting topological modifications
- Grinding and inspecting worms
- Grinding and inspecting spline shafts
- Grinding Hirth gearings
- Sharpening hobs

Further options on request



## USER-FRIENDLY SOFTWARE CONCEPT

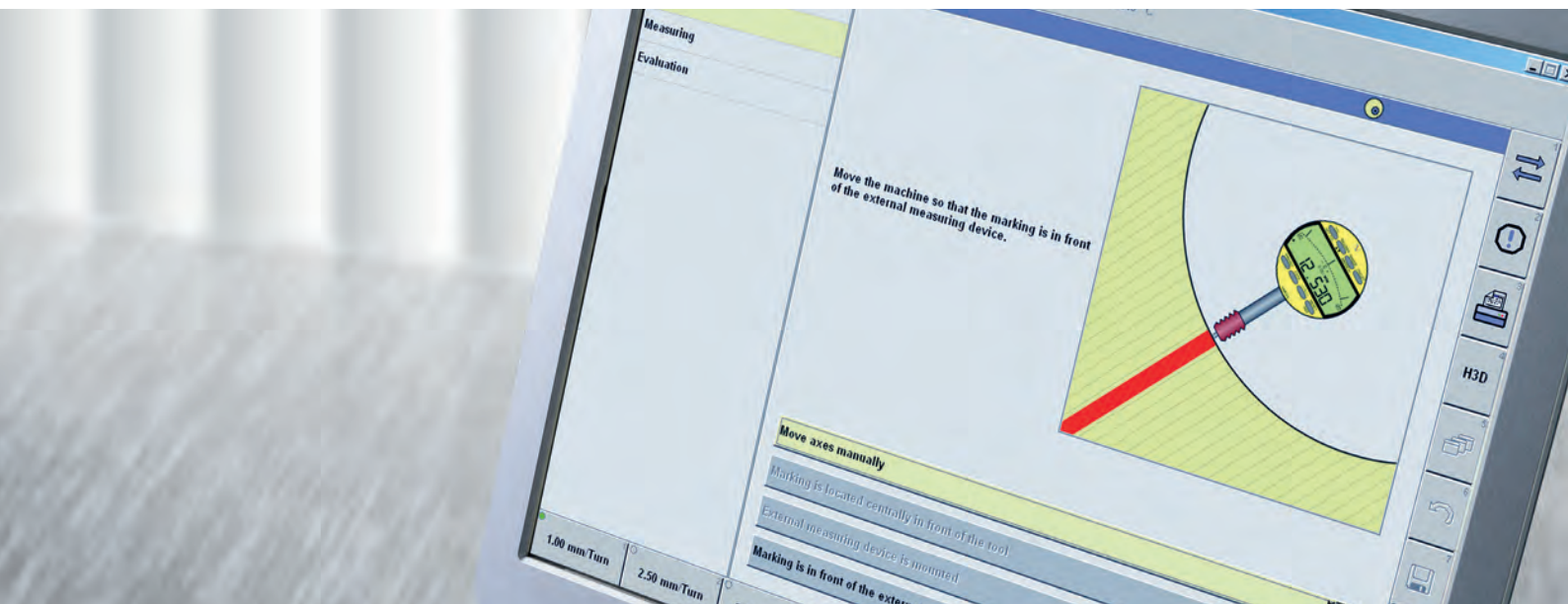

### Real Productivity Gains with Gear Production Software

Höfler gear grinding machines do not just stand apart due to their reliable, advanced hardware. The company's own Gear Production Software guarantees convenient machining of even the most complex topographies and ensures maximum efficiency in daily use. Only Gear Production delivers concentrated knowledge of state-of-the-art machining strategies and process sequences right to the user's hands.

And with its numerous options, Gear Production plays an active role in achieving productivity gains. Software modules for Best-fit Grinding, High-speed Grinding as well as adaptive grinding and dressing, have been developed to enable significant reductions in production times.

#### Pre-analysis/Job Engineering:

- Exact process time calculation with original machine data
- 3D analysis of the planned process steps with respect to working range and possible interference contours
- Tool wear pre-analysis
- Geometric production simulation with 3D analysis of the simulated flank topography
- Calculation and export of optimized tool profiles

#### Data Input/Navigation:

- Easy navigation through clearly structured interface areas
- Clear Microsoft® Windows®-like data management
- Intuitive data input via graphical display
- Clear operator guidance thanks to an automatically generated list of process steps
- Easy-to-understand input of even complex flank topographies and profile forms thanks to numerous context-sensitive wizards
- Various technology wizards for a range of tried-and-tested process variants

#### Automatic Archiving:

- Flank grinding stock and tooth traces for the blank
- Performance indicators for grinding
- Wear indicators for dressing
- Inspection charts of the finished part

# Maximum Process Efficiency with Gear Production Software

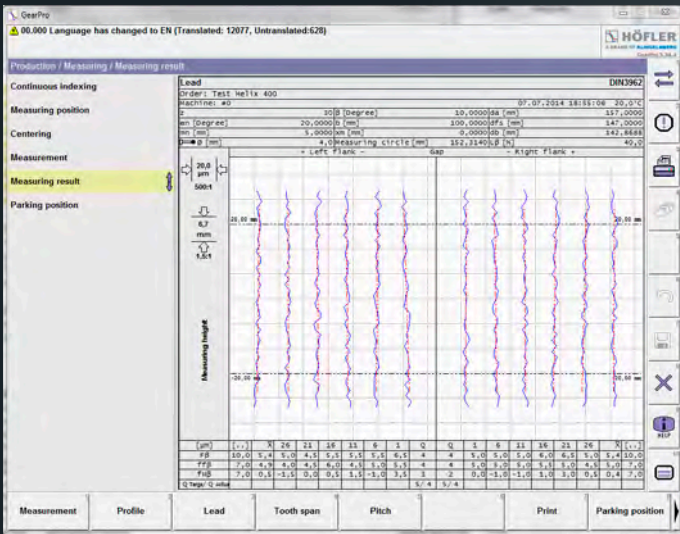

Measuring on the machine

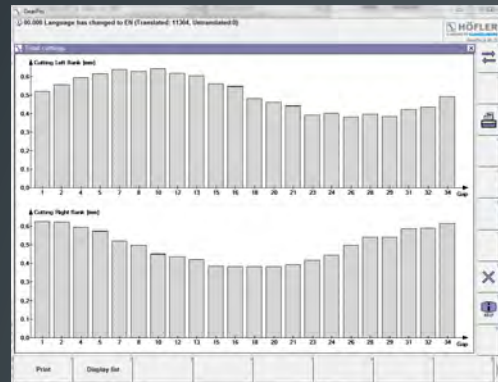

Grinding stock analysis

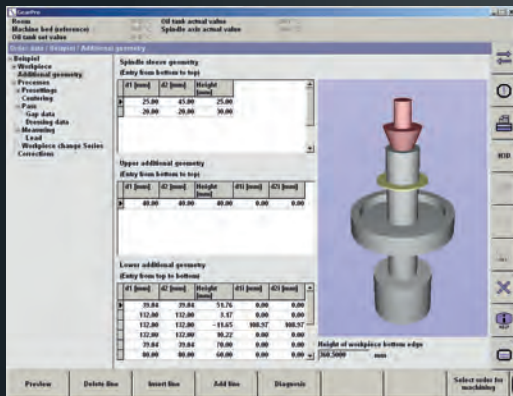

Graphical input of additional geometry for collision control

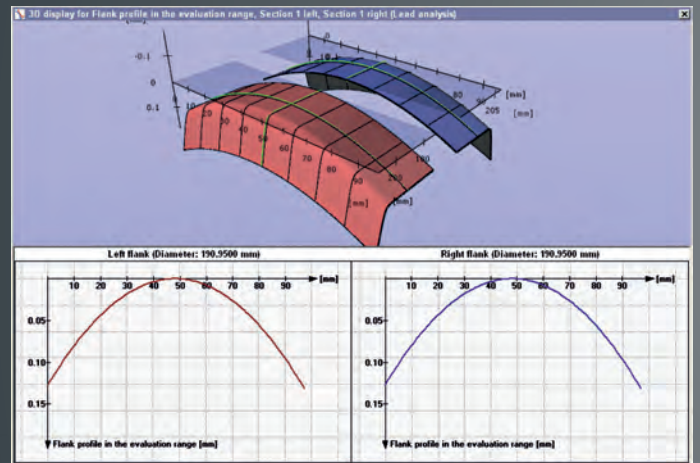

3D analysis of the simulated tooth profile

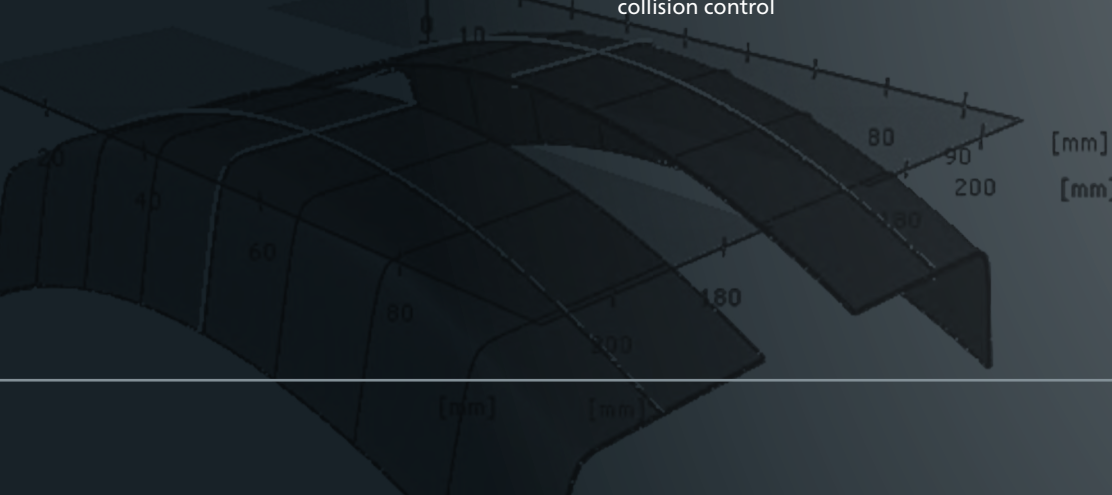

### Optimal Jobbing Performance – a Sure Thing Thanks to Drive Components with Guaranteed Quality

With the machines from the RAPID series and the internal gearing options, Klingelberg has developed a modular technology platform that gives contract gear manufacturers in particular a leg up on the competition thanks to maximum process efficiency and unparalleled production quality.

Like no other company, Klingelberg stands for intelligent solution concepts for just about every requirement. Thanks to a unique interplay between technology and software, machining jobs are made significantly easier – allowing for high productivity in mass production, while also providing tremendous flexibility in small-batch applications.

With its one-of-a-kind machine concept, the RAPID series provides levels of precision, reliability, and efficiency that are indispensable for contract gear manufacturers and gearbox manufacturers worldwide.



**Industrial Gear Units**



The industrial gear unit sector comprises many different applications, all of which place great demands on the reliability of gear wheels. The cylindrical gears for these sectors are often produced by companies specializing in small batch sizes and a great variety of products. A stiff machine design and flexible, cost-effective tool systems are the keys to success for ranking among the market leaders in these sectors.



**Mill Gears**

Used primarily in the cement industry and in coal-fired power plants, vertical mills are used to grind lime stone, clinker brick, and coal. The cylindrical gears used in these grinding processes are not only subjected to tremendous impact loads and environmental loads, they must also exhibit a high degree of efficiency in order to reliably ensure a continuous power transmission.

## Mining/Material Handling



Gear components used in production technology must withstand extremely challenging environmental conditions and service conditions. When used in belt drives, such as those used in coal production, strong temperature fluctuations and vibrations are the order of the day. Moreover, the cylindrical gears used in these gearboxes are subjected to intermittent, abrupt loads. Robustness and adequate load-bearing capacity are paramount requirements for these gear components.

## Contract Gear Manufacturers



Contract gear manufacturers in particular have to be able to react flexibly to market conditions on a daily basis and to produce a whole host of different gear components. From standard solutions to high-tech applications – Klingelberg offers its customers tailor-made machine concepts. These are supplemented by comprehensive engineering and other services, including everything from in-house machine certification at Klingelberg, to machine-attendant and software training, right through to production support.

## Wind Power



Only optimally cut cylindrical gears can be used in wind power applications. This is because only perfectly ground gear geometry provides optimal transmission of force for highly efficient wind power installations while ensuring extremely quiet running behavior. With Klingelberg solutions, high-precision gearing quality is a matter of course. It increases the service life of individual gearbox components, thereby significantly reducing maintenance costs.

## Maritime Propulsion Technology



The cylindrical gears used in shipbuilding must demonstrate excellent reliability and durability even under the most extreme external conditions. The wide range of component diameters requires extensive expertise for controlling the production process. Klingelberg's many years of experience and its certification by all major classification societies are the customer's guarantee of the utmost product quality.

# TECHNICAL DATA

	RAPID 2500	RAPID 3000	RAPID 4000
Outside gear wheel diameter (max.)	Ø 2,600 mm	Ø 3,000 mm	Ø 4,000 mm
Toothed gear root circle diameter (min.)	Ø 0 mm		Ø 580 mm
Axial stroke length	1,500 (2,020*) mm		
Working range over table (min. – max.)	540 – 2,040 (2,560*) mm		
Distance between centers over table (min. – max.)	1,000 – 2,300 (2,800*) mm		
Profile height (max.)	100 mm		
Module (min. – max.)	approx. 1 – 45***		
Pressure angle	no restriction		
Swiveling angle	–45°/+120°		
Grinding wheel diameter (max.)	Ø 450 mm		
Grinding wheel diameter, shoulder (min.)	Ø 206 mm		
Grinding wheel width (max.)	130 mm		
Grinding spindle drive (max.)	24 (37*) kW		
Tool slide stroke speed (max.)	6 (12*) m/min		
Table diameter	Ø 1,850 mm		Ø 2,350 mm
Table load (max.)	25,000 kg		40,000 kg
Table hole (diameter x depth)	Ø 750 x 1,300 mm		
Table rotation speed (min. – max.)	0 – 50 rpm		
Recommended table rotation speed during round ground operations (max.)	25 rpm		
Diamond dressing roll (diameter x depth)	Ø 120 x 26 mm		
Machine dimensions (L x W x H) incl. all standard components	approx. 9,900 x 8,400 x 5,200 (5,700**) mm	approx. 11,000 x 8,500 x 5,200 (6,000**) mm	approx. 10,500 x 9,200 x 5,200 (6,000**) mm
Net weight	approx. 65,000 – 67,000 kg**	approx. 68,000 – 70,000 kg**	approx. 70,000 – 73,000 kg**
Internal grinding*	Optional internal grinding arms available for small and large		

\* Charged separately

\*\* Depending on the version

\*\*\* Depending on the gear geometry; subject to change

## Space Requirements and Installation Dimensions

RAPID 6000	RAPID 8000
Ø 6,000 mm	Ø 8,000 mm
Ø 450 mm**	Ø 1,500 mm**
2,020 mm	
without counter support	
Ø 2,600 mm	Ø 3,200 mm
50,000 kg	100,000 kg
0 – 36 rpm	0 – 10 rpm
12 rpm	
approx. 14,300 x 11,600 x 6,500 mm	approx. 14,000 x 14,000 x 5,800 mm
approx. 82,000 kg**	approx. 95,000 kg**
gearing and/or AI version	

RAPID 6000: Front View

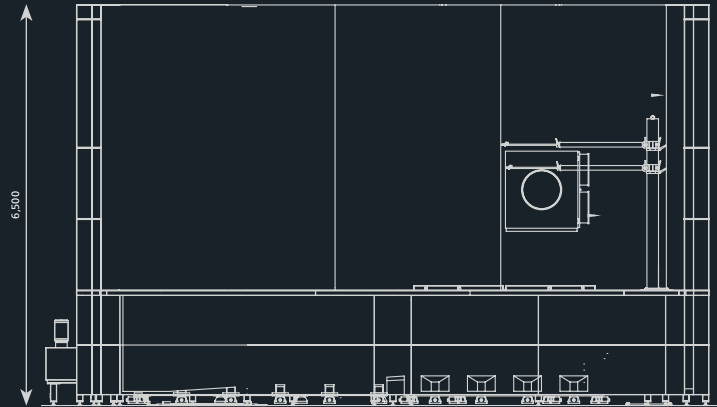

RAPID 6000: Top View

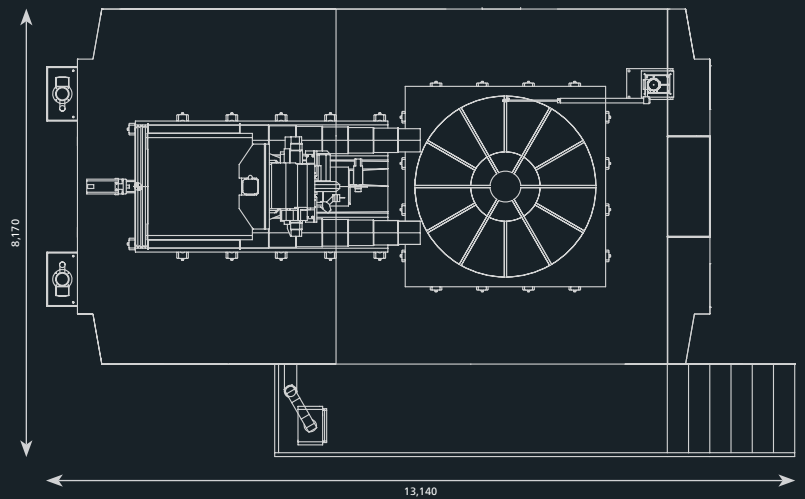

## KLINGELNBERG Service

The KLINGELNBERG Group is a world leader in the development and manufacture of machines for bevel gear and cylindrical gear production, and precision measuring centers for gearing and axially symmetrical components, as well as the production of customized high-precision drive components. In addition to the headquarters in Zurich, Switzerland, further development and production facilities are located in Hückeswagen and Ettlingen, Germany.

The company also maintains a presence with Sales and Service offices and numerous marketing agents. On this basis, Klingelberg offers users a comprehensive range of services for all aspects of toothed gear design, manufacturing, and quality inspection. The spectrum includes technical consulting, on-site machine acceptance, operator and software training as well as maintenance contracts.

## KLINGELNBERG Solutions

Klingelberg solutions are used in the automotive, commercial vehicle, and aviation industries, as well as in shipbuilding, the wind power industry, and the general transmission manufacturing industry. With numerous R&D engineers around the globe and over 200 registered patents, the company consistently demonstrates its capacity for innovation.

EN 12/2021 - Subject to technical modifications without notice.

FOLLOW US AND STAY UP TO DATE:



### KLINGELNBERG AG

Binzmühlestrasse 171  
8050 Zürich, Switzerland  
Fon: +41 44 278 7979  
Fax: +41 44 273 1594

### KLINGELNBERG GmbH

Peterstraße 45  
42499 Hückeswagen, Germany  
Fon: +49 2192 81-0  
Fax: +49 2192 81-200

### KLINGELNBERG GmbH

Industriestraße 5-9  
76275 Ettlingen, Germany  
Fon: +49 7243 599-0  
Fax: +49 7243 599-165

You can also find your local contact for sales advice at [www.klingelberg.com/en/contact](http://www.klingelberg.com/en/contact)