

OERLIKON

C 50

BEVEL GEAR TECHNOLOGY – CUTTING MACHINES



KLINGELBERG

A LEADER IN BEVEL GEAR TECHNOLOGY

Flexible Solutions for Discerning Users

All around the world, manufacturers of toothed gears and gear units ensure their leading edge in gear machining with innovative solution concepts from Klingelberg.

The [Oerlikon Bevel Gear Technology](#) division doesn't just make economical, high-precision production of bevel gears a reality for customers. All machines have been perfectly designed to work as a system family, enabling pre-machining and finishing of even the most complex gearings.

Klingelberg offers the most advanced technology and the most efficient machines for each and every step in the process chain. The production process chain for bevel gears includes [tool preparation](#), [cutting](#), [measuring](#), hardening, [grinding](#) or [lapping](#) and [testing](#), among others. The powerful [KIMoS \(Klingelberg Integrated Manufacturing of Spiral Bevel Gears\)](#) design software and the [Closed Loop concept](#) ensure transparency and documented quality throughout the entire process chain.

Oerlikon bevel gear machines were developed with real-world applications in mind and meet the varying demands of a whole range of application industries. The target markets include the automotive industry, the commercial vehicle industry, the agricultural industry, shipbuilding, and aviation, as well as industrial gearbox manufacturing and plant engineering.

As a leading system supplier, Klingelberg also offers high-performance tools and meets every requirement with its complete system for flexible, efficient production – from the smallest to the largest lot sizes.

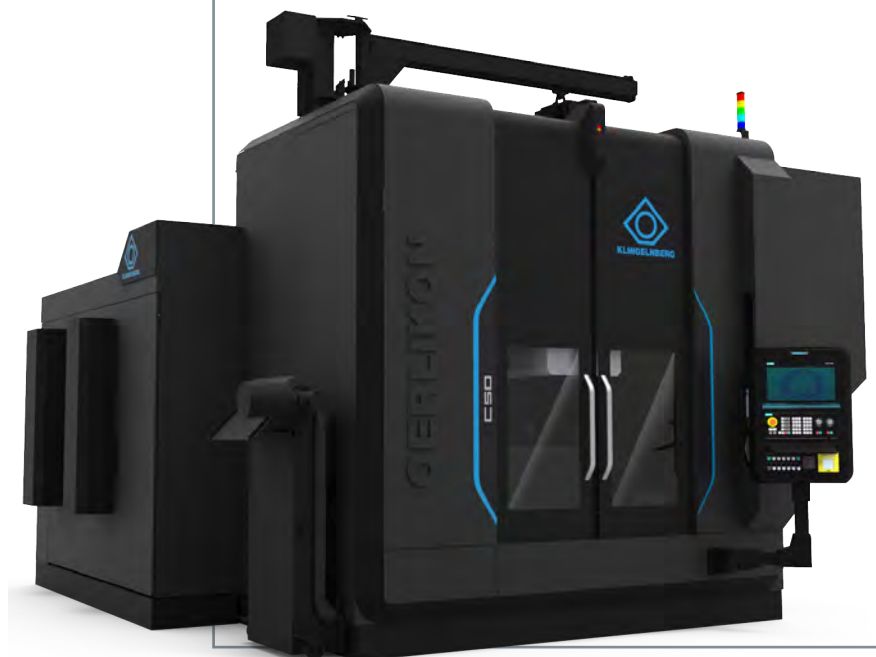

Oerlikon bevel gear cutting machine C 50 with numerous equipment details

Exceptional Concepts for Every Process Step in Gear Technology

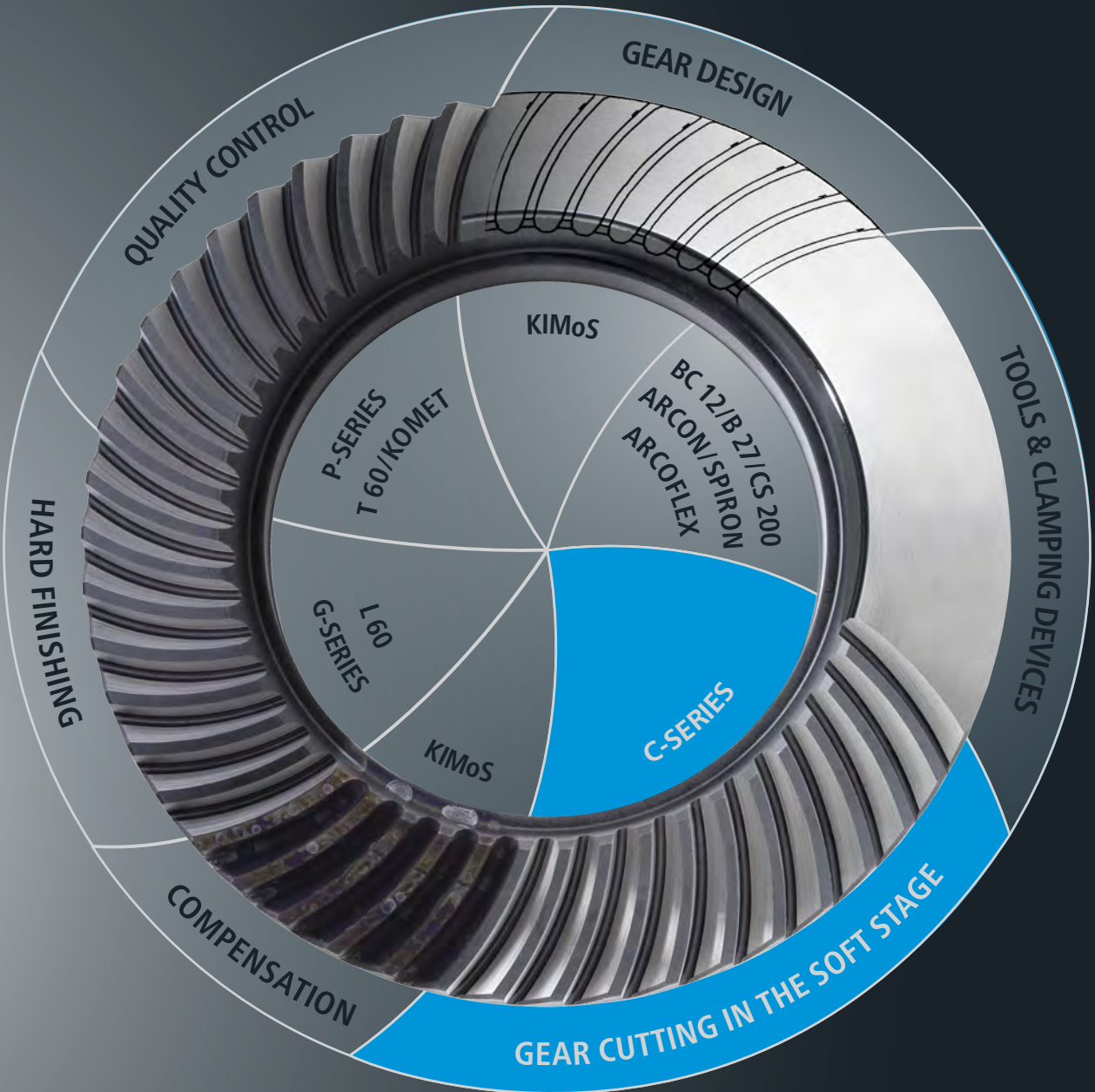

GEAR DEVELOPMENT BASED ON NOMINAL DATA

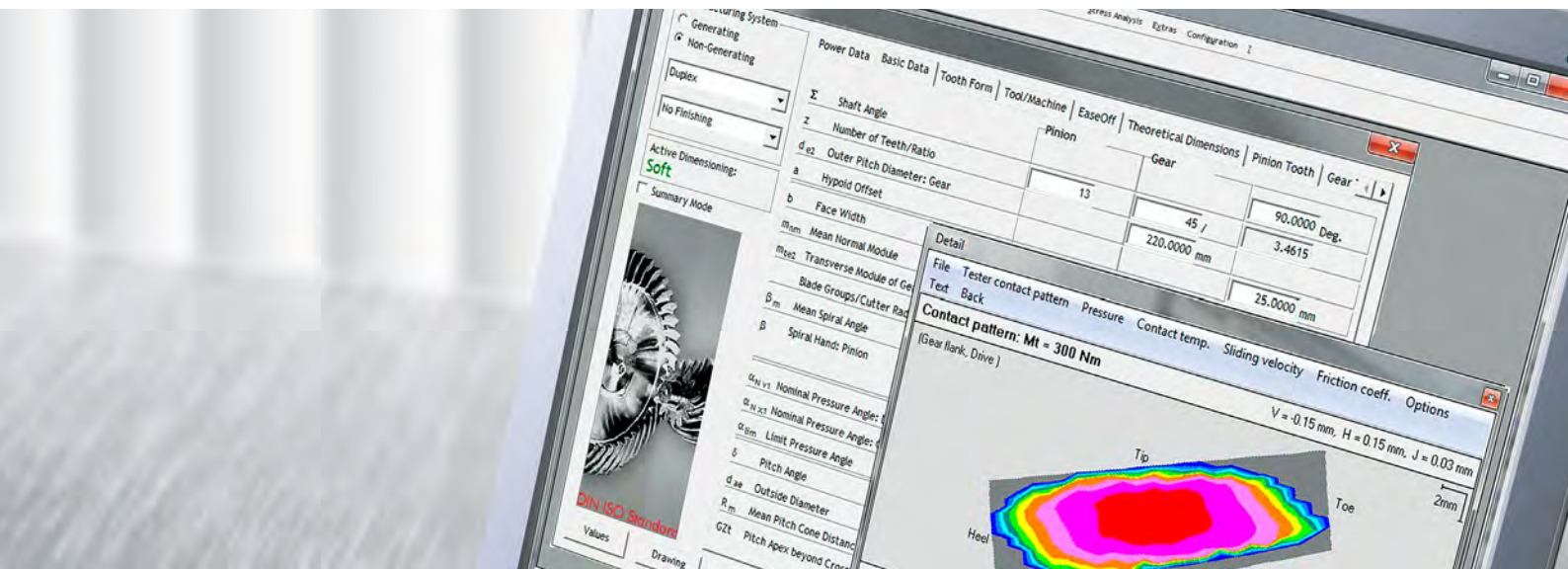

Digitizing Bevel Gear Production in the Age of Industry 4.0

The **KIMoS** (Klingelberg Integrated Manufacturing of Spiral Bevel Gears) software package supports every step in bevel gear design and optimization. Measuring results are converted into gear corrections with **KOMET**.

As part of this process, all of the necessary data for the gear cutting process, tool preparation and quality control of the finished bevel gears are prepared in parallel. At the same time, a convenient data handling system offers the possibility of using development and production databases to access machine tools in Production and Quality Assurance. The software package thus provides the optimal basis for ultra-modern bevel gear production according to the Closed Loop method: **The end result precisely matches what was previously designed and optimized on the computer.**

A modular program package, KIMoS provides the user with the whole range of functionality needed to create application-appropriate gear designs for every situation and supports all common gear-cutting methods, machines, and tool systems. Among the integral components of KIMoS are a gear-cutting optimization feature with easy-to-operate dialogs, analysis of the expected

gear operation behavior, and evaluation of the results with a load-capacity and strength calculation.

For gear design, KIMoS provides:

- Functional design with individual production possibilities taken into account
- Verification of gear design through various functions
- Cultivation of expertise within the company as a competitive advantage
- Fast, accurate analysis of testing and production results and gear damage

For gear production, KOMET provides:

- Reliable calculation of correction data in the precision measuring center
- Machine-specific correction data for bevel gear production
- Maximum process safety by interfacing with the Klingelberg database

Advanced Bevel Gear Production in a unique Closed Loop Process

KIMoS – for Optimal Design

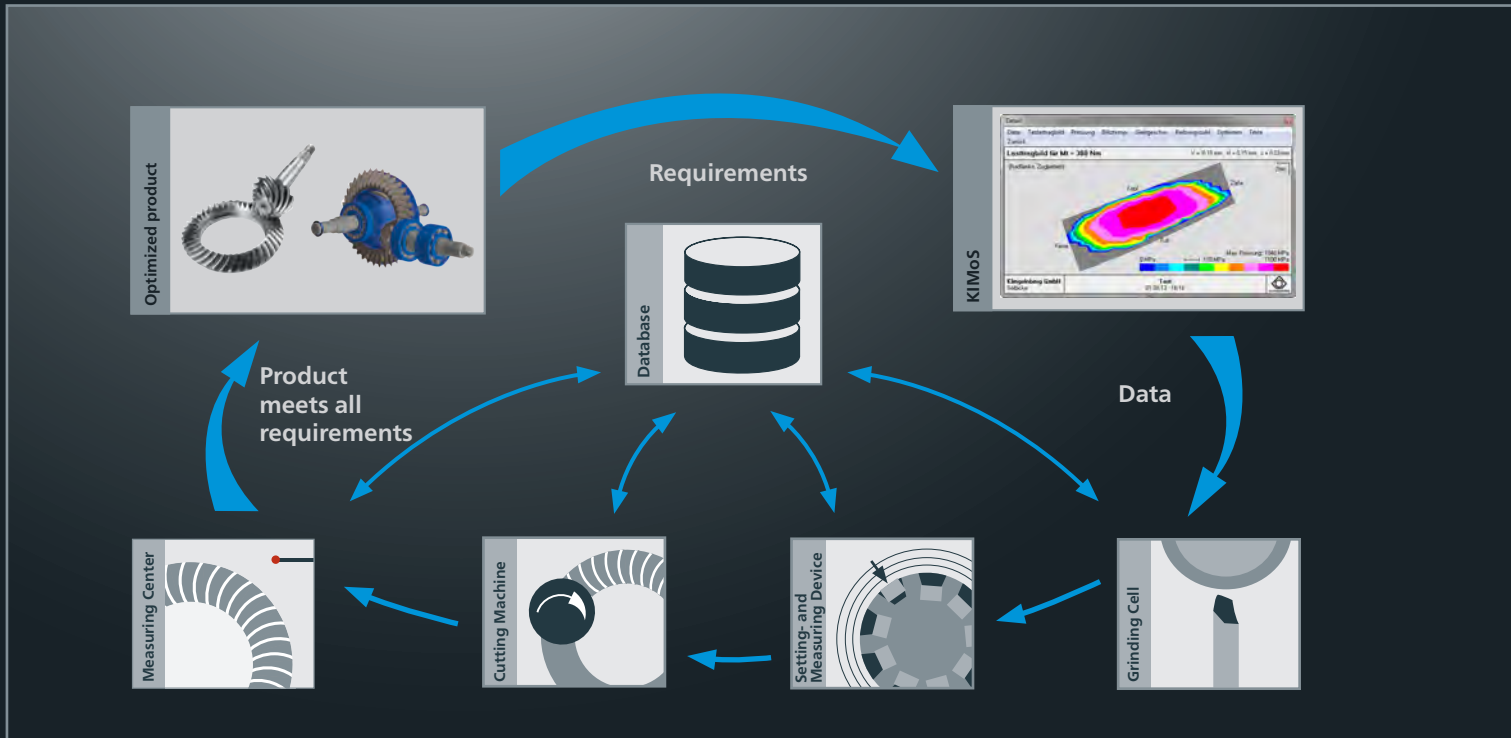

KOMET – from Design to Optimal Production Result

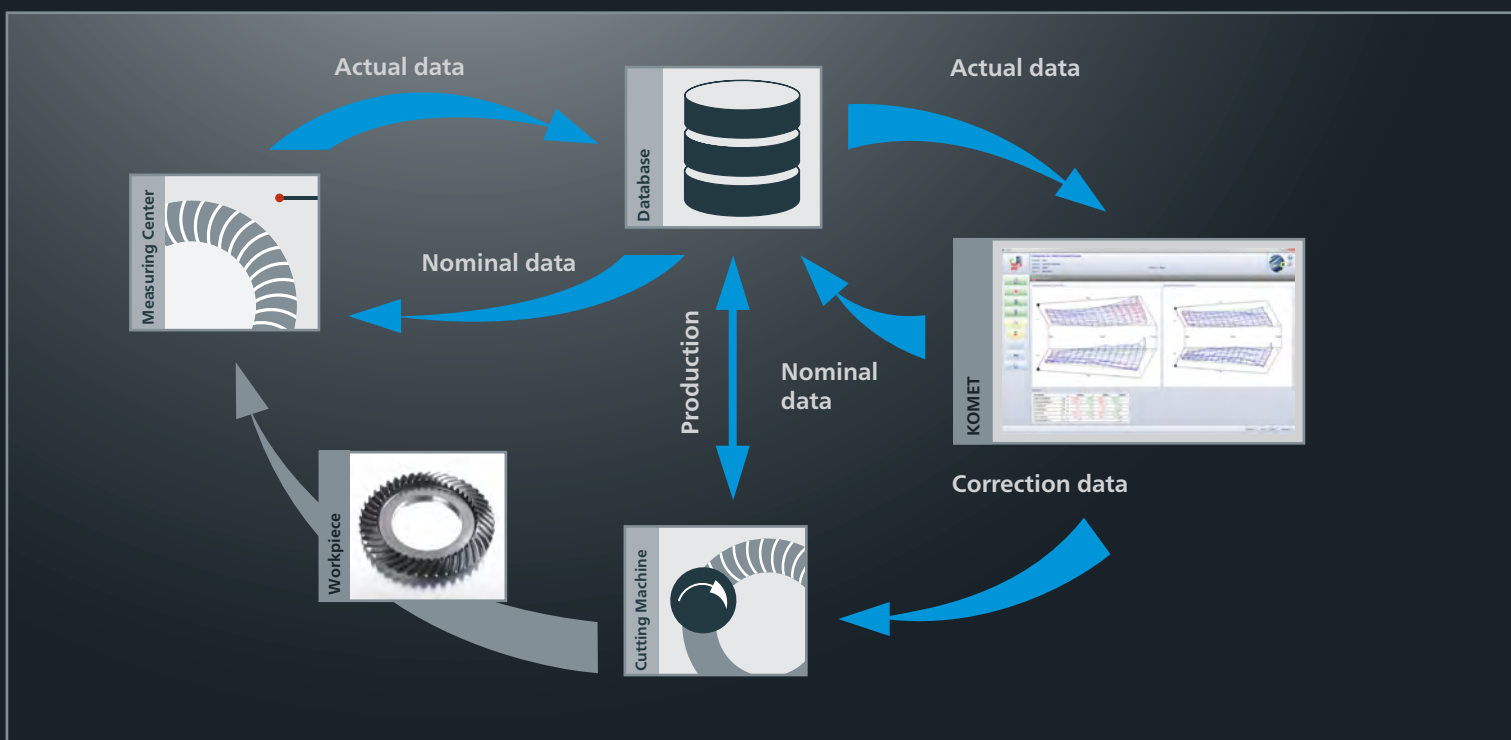

Leading-edge Technology for Optimal Flexibility and Maximum Productivity

Thanks to continuous further development of the vertical concept, the Oerlikon C 50 bevel gear cutting machine sets new standards in dry processing.

All bevel gear machines in this series provide maximum process stability thanks to their stable design and directly driven rotary axes. Optimal chip flow guarantees secure serial operation. An integrated workpiece deburring and workpiece measurement system add the finishing touches to modern bevel gear production.

The C50 offers maximum flexibility for customer-specific automation. The integrated workpiece loading makes it easy to connect a conveyor. Alternatively, a robot loading system is also available.

The tried and tested user interface guides the operator intuitively through the entire process.

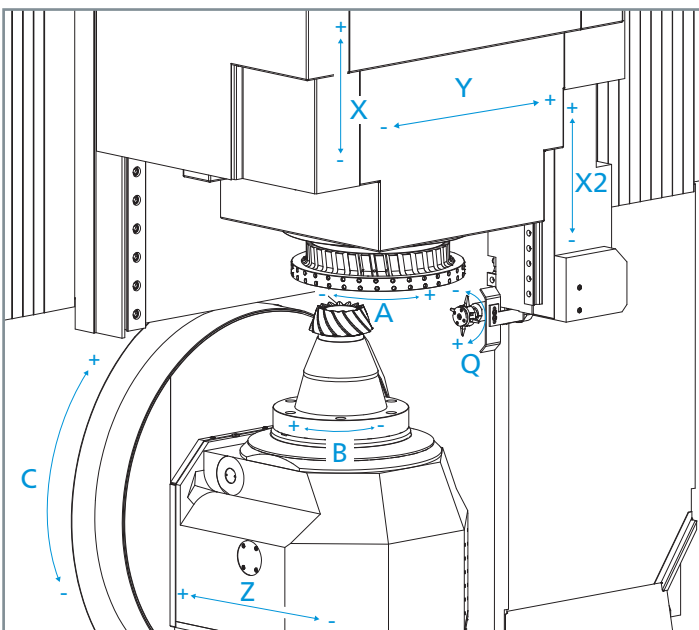

Axis arrangement of an Oerlikon C 50 bevel gear cutting machine

- Continuous further development of the vertical concept with minimal traversing paths
- New materials with optimal attenuation properties while providing an extremely rigid construction and thermal stability
- Integrated deburring in the same clamping as for gear cutting
- Vertical spindle arrangement makes clamping device changes easy
- Optimal energy efficiency thanks to recovery and on-demand control of units

High-quality Tool Systems Ideally Suited for Each Flank Profile



Circular arc (ARCON®)

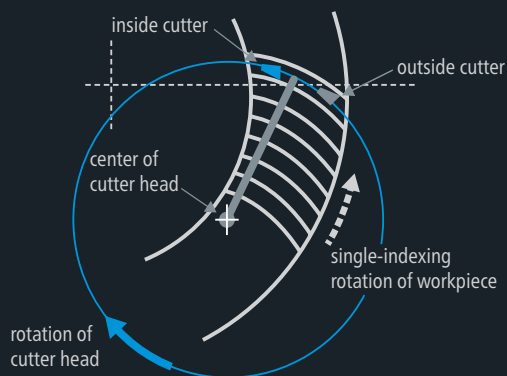

Epicycloid (SPIRON®)

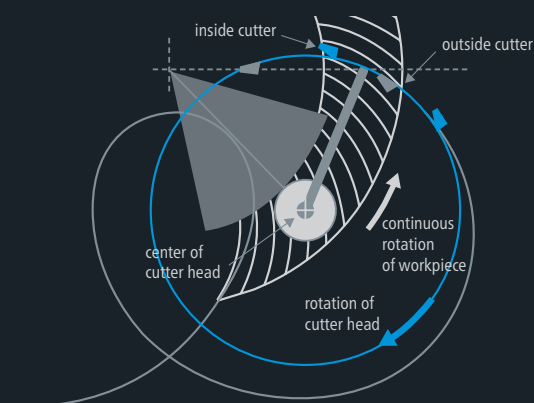

Straight gear (HYCON)

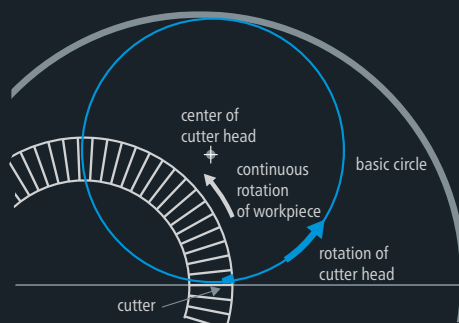

Success Story

As demonstrated by this example of a commercial vehicle ring gear with 41 teeth and a component outside diameter of 470 mm, the dry processing method cannot be beaten when it comes to speed:

- dry gear cutting in 255 seconds with the Klingelberg Arcon tool system
 - deburring of the concave tooth flank on the heel in 45 seconds with the Klingelberg deburring system
 - loading and unloading of the component in 39 seconds with the machine-integrated through-loading loader
 - optionally, the pitch can be measured on the machine for the first component and any individual pitch variations can be compensated automatically for the single indexing method
- the ring gear can thus be completely cut, deburred and changed out in just 339 seconds.

High-tech can be so easy!

"Simplified with Passion" – true to this motto, Klingelberg is driven to provide simple, unconventional solutions to high-tech challenges. A team of engineers and technical experts makes it possible – always with the goal of ensuring the highest technological standards in application-matched machine concepts that are also easy to use.

Case in point: the Oerlikon C 50 cutting machine is based on established development concepts that are continually being advanced. Klingelberg's success factors include:

- High productivity with the lowest possible per-piece costs and maximum process safety
- Unique Closed-Loop concept for the entire bevel gear cutting process chain
- Improved tool system and just-in-time grinding service
- Comprehensive service offering with a broad service network
- Outstanding technical expertise and expert knowledge, which Klingelberg passes on to customers in professional seminars

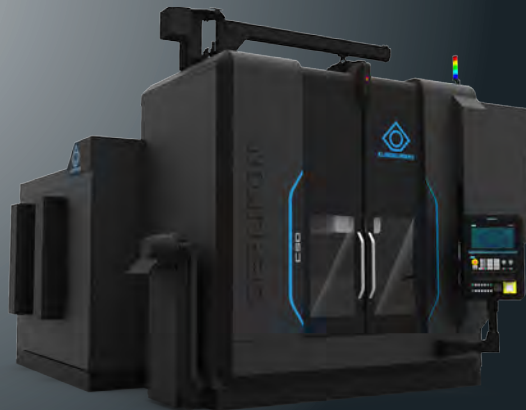

Oerlikon bevel gear cutting machine C 50, customer-specific variant with numerous equipment details



Optimal Chip Flow Thanks to Vertical Axis Concept

- Minimal heat input thanks to systematic avoidance of chip deposits in the working chamber
- Separate working chamber to protect drive components
- Foundation for trend-setting high-speed machining
- Improved axis arrangement allows for optimal process monitoring
- Moving parts protected from damage caused by chips both inside and outside the working chamber
- Optimal energy efficiency thanks to recovery and on-demand control of units



Minimal Setup Times

- Vertical axis concept provides easy access to workpiece clamping device
- Bayonet connector speeds up clamping device changes
- Integrated workpiece measurement system for automatic quality monitoring and faster production release following a component change
- Blade breakage monitoring allows for fast response to minimize downtime



Intelligent Production Process for Maximum Efficiency

- Temperature compensation inside the machine ensures maximum precision
- Short processing times and low tool costs make for extremely economic production processes
- Intuitive operating concept
- Top-notch quality through automatic pitch compensation in the face milling process via software settings
- Investment protection provided by tool breakage monitoring



Energy Efficiency for Maximum Savings

- As-needed control of the chip conveyor with energy-saving stand-by mode
- Energy-saving cooling technology thanks to effective control of the cooling units
- High efficiency-class motors
- Intelligent reactive current compensation
- Efficient energy recovery

HIGHLIGHTS



Minimal Auxiliary Times Thanks to Integrated Workpiece Change

- Optimized workpiece changes, since loading system is fully integrated into the machine
- Automation interface in accordance with VDMA directive 34180
- Integrated NC axes means intelligent coordination of the machining process and workpiece changes



Closed Loop Technology on the Machine with the Integrated KOMPASS Measurement System

- Series production control at the press of a button by means of a network to KOMET. Correction of flank profile deviations and tooth thickness based on certified P machine measurement
- KOMPASS startup control at the press of a button through machine-integrated measurement option, and subsequent KOMET correction directly on the machine
- Flank shape measurement of a component cut with allowance against nominal measured data adapted automatically to this allowance
- Highlight: automatic pitch compensation immediately following pitch measurement for components produced using the single indexing method

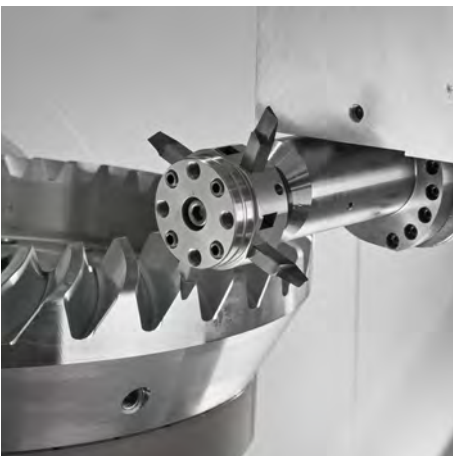

Flexible Deburring

- Visualization of the deburring paths ensures collision protection between the deburring tool, bevel gear cutting machine, and component
- Early-stage validation of production equipment and fast deburring setup, since all deburring development takes place outside the cutting machine
- Easy loading of centrally stored deburring processes minimizes tooling time during setup
- Deburring calculation for flank profiles of various manufacturing methods

Automation Concepts

Automation with Machine-integrated Automatic Loading Equipment:

- Optimal solution for an external conveyor
- One-sided or two-sided solution concepts
- Minimal cycle times with two-sided design
- Easy integration of standard solutions for conveyor belts

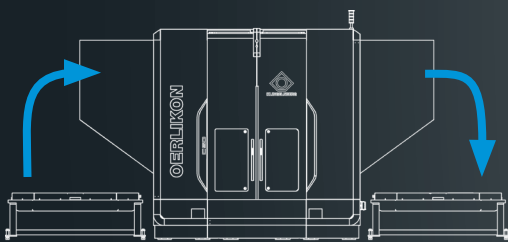
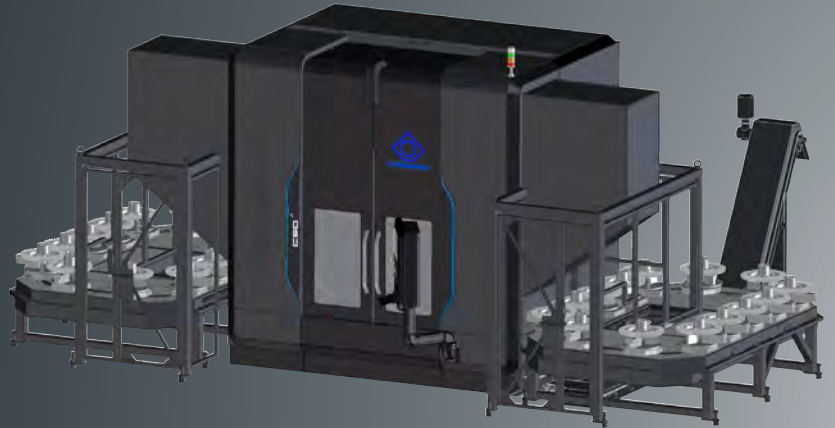

On both sides

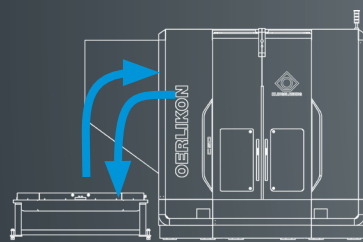

From the left

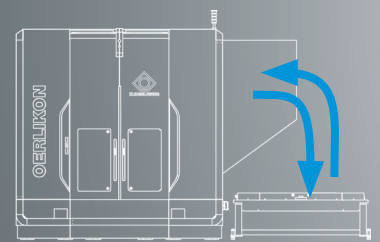

From the right

Automation with External Robot Cell:

- Optimal for connecting to a stacking cell
- Flexible expansion of functional scope (SPC drawer, gripper change from ring gear to pinion, blank control, etc.)
- Integration option from the right or left

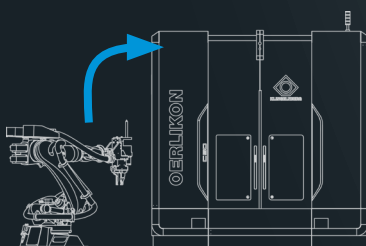
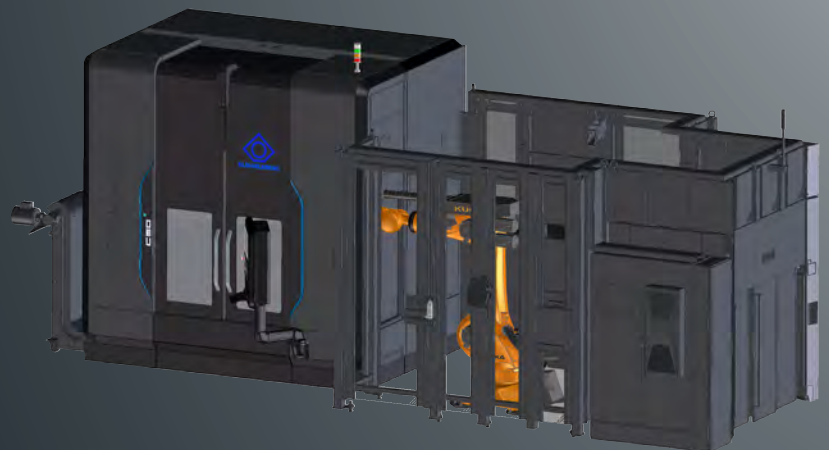

From the left

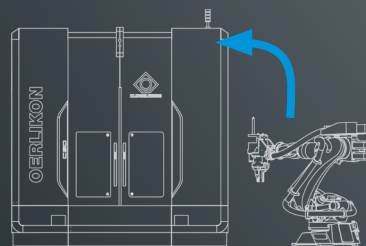

From the right

EXPERTISE IN COUNTLESS INDUSTRIES

Drive Components with Guaranteed Quality Provide Optimal Performance

In countless industries, Klingelberg solutions have become a fixture in the international market. To meet market requirements for high productivity in mass production and flexibility in small-batch production, Klingelberg offers a range of solution concepts for just about any requirement.

Used throughout the world, the [Simplified with Passion](#) system plays an important part in ensuring that machine tasks are made simple. Moreover, the Klingelberg system contributes to standardization and quality assurance on a global scale.



Commercial Vehicles



Commercial vehicles are always rear-wheel-driven. The bevel gear sets they use must transmit power in the range of 550 kW – at extremely high torques. This places high demands on durability and strength. The bevel gear sets must be efficient, robust and low-maintenance. Use of the integrated Klingelberg system makes it possible to mass-produce bevel gears with the quality required.

Mining/Material handling



In mining and tunnel construction as well as materials handling, extreme demands are made of people and machinery due to the high volumes that are transported. The quantities that are handled nowadays are only possible as a result of technical developments in loading and transport systems. Whether above ground (surface mining) or below, whether using continuous technology or traditional truck and shovel excavation – the key competitive criteria for the technology are always the same: outstanding reliability and safety against failure, as well as low-wearing, energy-efficient operation.

Industrial Gear units



The industrial gear unit sector comprises many different applications, all of which place great demands on the reliability of the drive components. The bevel gears for these sectors are often produced by companies specializing in small lot sizes and a variety of products. A rigid machine design as well as flexible and cost-effective tool systems are the key to success in order to be a market leader here.

Aviation



Bevel gears used in airplanes must meet the highest quality grades in terms of pitch and concentricity (DIN 1–3) and must also execute rotary motions with absolute reliability. Just as important are other geometrical features such as surface finish, tooth root geometry, rotational error, high strength, and low weight. Frequently used in this industry are specialty materials, which place extreme demands on tools and processes.

Railway Gears



The railway industry is deeply rooted in the industrial landscape. Growing environmental and climate protection requirements are dictating the pace here, too: Although rail transport already has a good environmental and climatic report card per se, companies in the industry are already investing in research and development in order to be prepared for the increasing demands of the future. In addition to lightweight design of rail motor units, they focus their efforts on developing components and drive systems with even lower emissions and greater energy efficiency.

Agriculture



In agricultural applications such as tractors, spiral bevel gears are built into the rear axles, as well as the front axles in certain cases. Harvesters and hay machines use straight bevel gears to enable the corresponding functions. Whereas the bevel gear set in a tractor rear axle drive must transmit up to 400 kW, the loads on straight bevel gears are comparably low. The most important market requirement for straight bevel gears is a modern, cost-efficient production solution.

TECHNICAL DATA

	Face hobbing (continuous indexing)	Face milling (single indexing)
Workpiece data		
Workpiece diameter (max.)	Ø 500 mm	
Normal module range (min. – max.)	1.5 – 9 mm	1.5 – 11 mm
Face width (max.)	90 mm	
Smallest / largest spiral angle	0°/60°	
Smallest / largest number of teeth	6/180	
Smallest / greatest transmission ratio	1:1/1:10	
Tool data		
Cutter head radius / Cutter head diameter	88 – 181 mm	6" – 16"
Number of blade groups (continuous)	5 – 19	-
Cutter head spindle (A axis)		
Seating diameter: Gleason outer cone no. 14: 1:24	Ø 58.227 mm	
Cutter head spindle rotation speed (max.)	450 rpm	
Workpiece spindle (B axis)		
Seating diameter: Oerlikon inner cone no. 80, 1:16	Ø 203.218 mm	
Work spindle passage	Ø 190 mm	
Workpiece spindle rotation speed (max.)	450 rpm	
Total connected load	50 kVA	
Machine dimensions L x W x H	approx. 4,910 x 5,680 x 3,350 mm (with integrated workpiece loading)	
	approx. 4,860 x 3,300 x 3,350 mm (without integrated workpiece loading)	
Net weight	approx. 33,500 kg	

The above-mentioned maximum values were determined for industry-typical transmissions. Further testing may be required to determine whether maximum values can be combined.

Installation Dimensions

With Workpiece Loading Front View and Top View

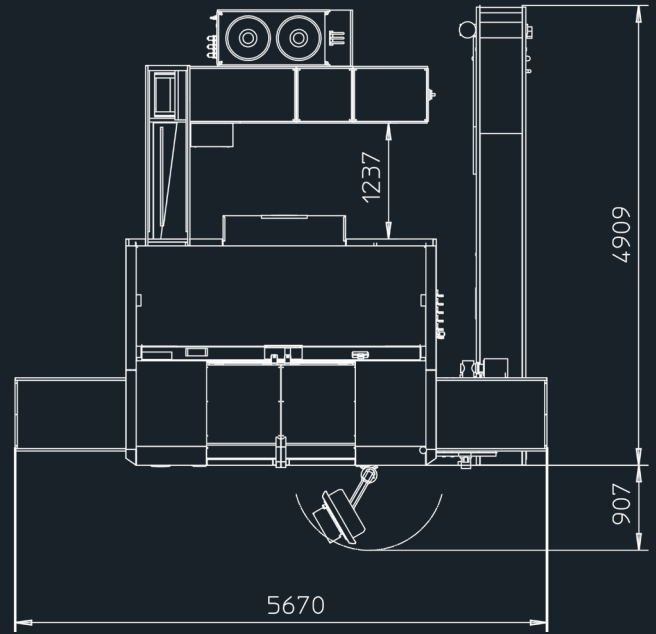
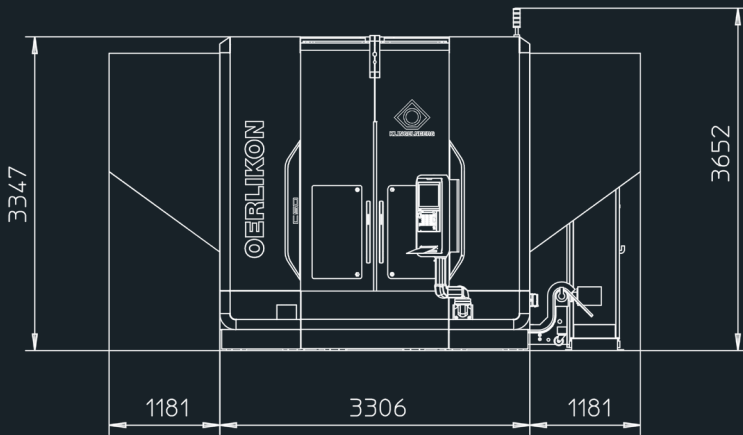

Without Workpiece Loading Front View and Top View

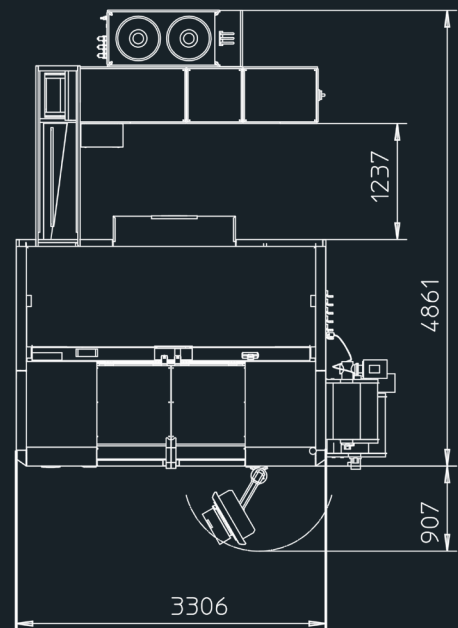
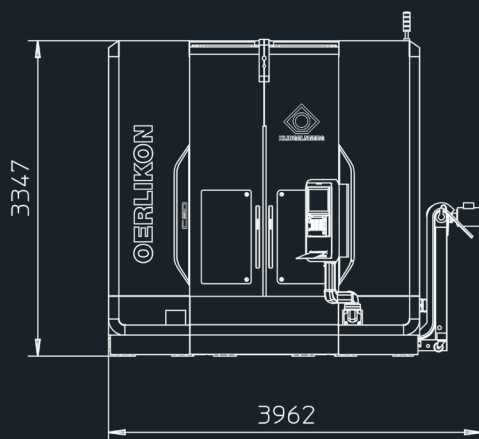

All specifications in mm

KLINGELNBERG Service

The KLINGELNBERG Group is a world leader in the development and manufacture of machines for bevel gear and cylindrical gear production, and precision measuring centers for gearing and axially symmetrical components, as well as the production of customized high-precision drive components. In addition to the headquarters in Zurich, Switzerland, further development and production facilities are located in Hückeswagen and Ettlingen, Germany.

The company also maintains a presence with Sales and Service offices and numerous marketing agents. On this basis, Klingelberg offers users a comprehensive range of services for all aspects of toothed gear design, manufacturing, and quality inspection. The spectrum includes technical consulting, on-site machine acceptance, operator and software training as well as maintenance contracts.

KLINGELNBERG Solutions

Klingelberg solutions are used in the automotive, commercial vehicle, and aviation industries, as well as in shipbuilding, the wind power industry, and the general transmission manufacturing industry. With numerous R&D engineers around the globe and over 200 registered patents, the company consistently demonstrates its capacity for innovation.

EN 12/2020 - Subject to technical modifications without notice.

FOLLOW US AND STAY UP TO DATE:



KLINGELNBERG AG

Binzmühlestrasse 171
8050 Zürich, Switzerland
Fon: +41 44 278 7979
Fax: +41 44 273 1594

KLINGELNBERG GmbH

Peterstraße 45
42499 Hückeswagen, Germany
Fon: +49 2192 81-0
Fax: +49 2192 81-200

KLINGELNBERG GmbH

Industriestraße 5-9
76275 Ettlingen, Germany
Fon: +49 7243 599-0
Fax: +49 7243 599-165

You can also find your local contact for sales advice at www.klingelberg.com/kontakt